



THE INDUSTRY STANDARD

The Tommy Gate G2 Series is a dual-cylinder, parallel-arm design which utilizes a pair of hydraulic cylinders to lower and raise the lift by applying direct power to both sides of the platform. G2 Series liftgates for pickups are versatile, popular, and modern.

G2-60-1542 EA38

Shown with optional rubber platform bumpers and discontinued recessed light kit. Recessed lights have been replaced by a bolt-on kit.

Frames and platforms on every G2 Series liftgate are hand assembled and hand welded, while precision parts are laser cut and/or robotically welded.



DUAL-DRIVE ADVANTAGES

Dual-drive liftgates provide increased durability for rigorous cycling and have low maintenance requirements. A paint-before-assembly process also increases the longevity of the lift's aesthetics.

G2 SERIES LIFTGATE FEATURES

- Dual hydraulic cylinders
- Virtually maintenance-free components
- Recessed control
- Larger platforms
- Fully-enclosed hydraulic system located within the lift mainframe



AVAILABLE MODELS

TWO-YEAR STANDARD WARRANTY





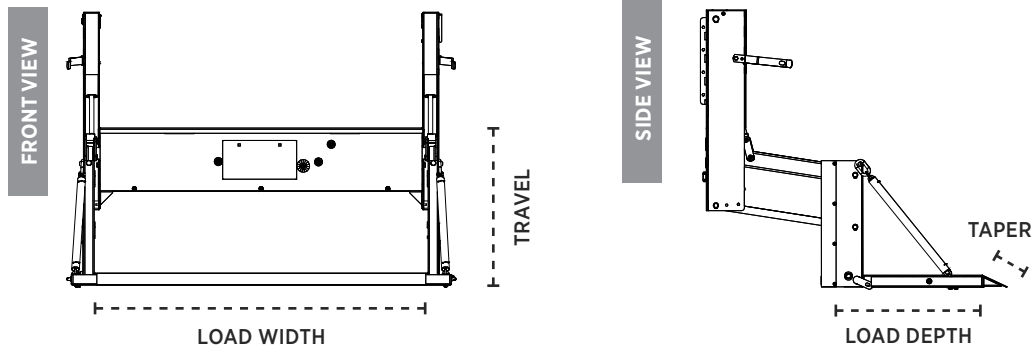

	Model Number	Load Area	Taper	Travel	Platform Fold	Application ¹	Gate Weight
1300 lb. Capacity	Treadplate Platforms						
	G2-60-1342 TP27	55 x 27	4	42	No	A,B	438
	G2-60-1342 TP38	55 x 38	4	42	Yes	A,B	478
	G2-60-1342 TP42	55 x 42	7	42	Yes	A,B	503
	TommyTraction™ Platform						
	G2-60-1342 TT27	55 x 27	4	42	No	A,B	439
	Aluminum Platforms						
	G2-60-1342 EA27	55 x 27	6	42	No	A,B	395
	G2-60-1342 EA38	55 x 38	6	42	Yes	A,B	421
	G2-60-1342 EA48 ²	55 x 48	6	42	Yes	A,B	442
Bar Grate Platform							
G2-60-1342 BG27	55 x 27	4	42	No	A,B	445	
1500 lb. Capacity	Treadplate Platforms						
	G2-60-1542 TP27	55 x 27	4	42	No	B	438
	G2-60-1542 TP38	55 x 38	4	42	Yes	B	478
	G2-60-1542 TP42	55 x 42	7	42	Yes	B	503
	TommyTraction™ Platform						
	G2-60-1542 TT27	55 x 27	4	42	No	B	439
	Aluminum Platforms						
	G2-60-1542 EA27	55 x 27	6	42	No	B	395
	G2-60-1542 EA38	55 x 38	6	42	Yes	B	421
	G2-60-1542 EA48 ²	55 x 48	6	42	Yes	B	442
Bar Grate Platform							
G2-60-1542 BG27	55 x 27	4	42	No	B	445	
G2 MODELS FOR MID-SIZED PICKUPS							
750 lb. Capacity	Treadplate Platforms						
	G2-54-7542 TP38	49 x 38	4	42	Yes	G	421
	Aluminum Platforms						
G2-54-7542 EA38	50 x 38	6	42	Yes	G	369	

G2 SERIES DIMENSIONS ³









1. See applications on page 51.
2. EA48 platform extends 10" above top of liftgate mainframe. See image on page 13.
3. For detailed dimensions, visit www.tommygate.com



STANDARD FEATURES



	Fixed and Timed Toggle Control
	Recessed Control
	Vehicle-specific Mounting Brackets
	Power Cable with Full-length Ground
	150-amp Circuit Breaker
	Maintenance-free Pins and Bushings
	Drop-away Platform
	Hitch Compatible ¹

AVAILABLE OPTIONS

	Remote Pendant Control
	Dual Controls
	Rubber Platform Bumpers
	Bolt-on, 3-Light, LED Light Kit
	Bolt-on, 2-Light, LED Light Kit
	Galvanized Frame and Platform ³
	Rear Camera and Sensor Bar
	Folding Tire Rack ²

1. Compatible with many hitches. Visit www.tommygate.com to view complete hitch chart.
2. Not compatible with folding platforms. See spec charts.
3. Galvanized option not available with Steel Treadplate platforms. Call factory for ordering details.

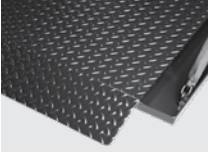
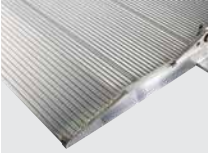
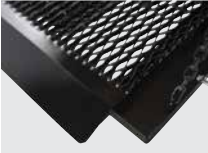
PLATFORM MATERIALS

	Steel Treadplate
	Extruded Aluminum
	TommyTraction
	Steel Bargrate

GALVANIZING OPTION

A high-quality galvanized finish supports long-lasting performance and appearance in even the most extreme climate conditions.

*Not available with Steel Treadplate platforms.
Call factory for ordering details.*



STEEL PLATFORMS

TP27 - 27" Loading Depth



TP38 - 38" Loading Depth



TP42 - 42" Loading Depth

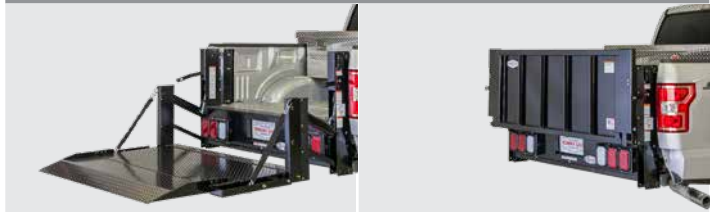

ALUMINUM PLATFORMS

EA27 - 27" Loading Depth



EA38 - 38" Loading Depth



EA48 - 48" Loading Depth (EXTENDS ABOVE TRUCK BOX)







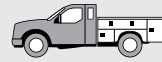

THE INDUSTRY STANDARD

The Tommy Gate G2 Series is a dual-cylinder, parallel-arm design which utilizes a pair of hydraulic cylinders to lower and raise the lift by applying direct power to both sides of the platform. With forty-two inches of vertical travel, the G2 Series is a great fit for most any service body.

G2-60-1542 EA38

Shown with optional rubber platform bumpers and discontinued recessed light kit. Recessed lights have been replaced by a bolt-on kit.

Hydraulic cylinders are built in-house. Precision cylinder welds are executed by robotic machines, while assembly and testing are done by hand.



G2 SERIES LIFTGATE FEATURES

- Dual hydraulic cylinders
- Virtually maintenance-free components
- Recessed control
- Larger platforms
- Fully-enclosed hydraulic system located within the liftgate mainframe



Dual-drive liftgates provide increased durability for rigorous cycling and have low maintenance requirements. A paint-before-assembly process also increases the longevity of the lift's aesthetics.



MODELS FOR SERVICE BODIES WITH 48" OPENING

TWO-YEAR STANDARD WARRANTY

	Model Number	Load Area	Taper	Travel	Platform Fold	Gate Weight
1300 lb. Capacity	Treadplate Platforms					
	G2-54-1342 TP27	49 x 27	4	42	No	415
	G2-54-1342 TP38	49 x 38	4	42	Yes	453
	G2-54-1342 TP42	49 x 42	7	42	Yes	477
	TommyTraction™ Platform					
	G2-54-1342 TT27	50 x 27	4	42	No	416
	Aluminum Platforms					
	G2-54-1342 EA27	49 x 27	6	42	No	375
	G2-54-1342 EA38	49 x 38	6	42	Yes	399
	G2-54-1342 EA48¹	49 x 48	6	42	Yes	419
Bar Gate Platform						
G2-54-1342 BG27	50 x 27	4	42	No	422	
1600 lb. Capacity	Treadplate Platforms					
	G2-54-1642 TP27	49 x 27	4	42	No	415
	G2-54-1642 TP38	49 x 38	4	42	Yes	453
	G2-54-1642 TP42	49 x 42	7	42	Yes	477
	TommyTraction™ Platform					
	G2-54-1642 TT27	50 x 27	4	42	No	416
	Aluminum Platforms					
	G2-54-1642 EA27	49 x 27	6	42	No	375
	G2-54-1642 EA38	49 x 38	6	42	Yes	399
	G2-54-1642 EA48¹	49 x 48	6	42	Yes	419
Bar Gate Platform						
G2-54-1642 BG27	50 x 27	4	42	No	422	

ADDITIONAL BODY SIZES







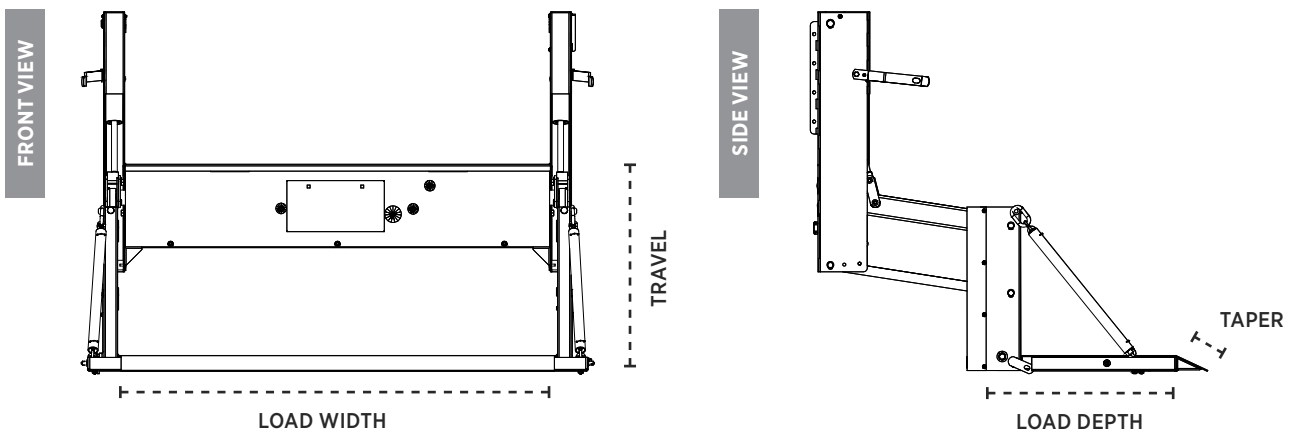

Body Opening	Model	Description
54"	60SB	55" Load Area width

1. See applications on page 51.
2. EA48 platform extends 10" above top of liftgate mainframe. See image on page 19.
3. For detailed dimensions, visit www.tommygate.com







G2 SERIES DIMENSIONS³



STANDARD FEATURES

	Fixed and Timed Toggle Control
	Recessed Control
	Vehicle-specific Mounting Brackets
	Power Cable with Full-length Ground
	150-amp Circuit Breaker
	Maintenance-free Pins and Bushings
	Drop-away Platform
	Hitch Compatible ¹

AVAILABLE OPTIONS

	Remote Pendant Control
	Dual Controls
	Rubber Platform Bumpers
	Bolt-on, 3-Light, LED Light Kit
	Bolt-on, 2-Light, LED Light Kit
	Folding Tire Rack ²
	Galvanized Frame and Platform ³

PLATFORM DROP-CHAIN COVERS PROVIDE A QUIETER RIDE.



1. Compatible with many hitches. Visit www.tommygate.com to view complete hitch chart.
2. Not compatible with folding platforms. See spec charts.
3. Galvanized option not available with Steel Treadplate platforms. Call factory for ordering details.

PLATFORM MATERIALS

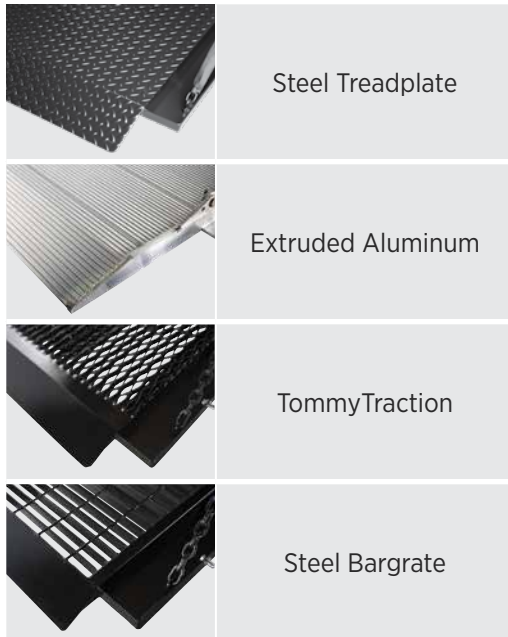

GALVANIZING OPTION

A high-quality galvanized finish supports long-lasting performance and appearance in even the most extreme climate conditions.

*Not available with Steel Treadplate platforms.
Call factory for ordering details.*



STEEL PLATFORMS

TP27 - 27" Loading Depth



TP38 - 38" Loading Depth



ALUMINUM PLATFORMS

EA38 - 38" Loading Depth



EA48 - 48" Loading Depth (EXTENDS ABOVE TRUCK BOX)



ALUMINUM PLATFORMS ARE COMPRISED OF INTERLOCKING, 6061-T6 AIRCRAFT-QUALITY EXTRUSIONS.

