



VAN PARTITIONS

Our safety partitions protect the most important asset: You!



SAFE

Designed for maximum impact resistance. Proven by impact testing.



EFFICIENT

- 1. Contoured to maintain seat travel and ensure driver comfort.
- 2. Contoured to capitalize on cargo area floor space.



QUIET

Thickness of material cancels vibrations.

VAN PARTITIONS

APPLICATION GUIDE P. 32

CONTOURED

CLEARSHIELD P. 35
 COMPOSITE PARTITION P. 35
 COMPOSITE WITH WINDOW P. 36
 CONTOURED FULL PARTITION P. 41
 CONTOURED WITH WINDOW P. 37
 CONTOURED WITH PERFORATED WINDOW P. 39
 CONTOURED WIRE MESH P. 43
 MAX VIEW P. 34

STRAIGHT

STRAIGHT MID POSITION P. 48
 STRAIGHT WITH PERFORATED WINDOW, NO ACCESS P. 44
 STRAIGHT WITH PERFORATED WINDOW, SWING DOOR P. 46
 STRAIGHT WITH WINDOW, SLIDING DOOR P. 47

WALK THROUGH

STRAIGHT WALK THROUGH PARTITION P. 49

ACCESSORIES P. 49







Ranger Design safety partitions provide a solid and secure barrier between the occupants of the van and the cargo.

Built from heavy gauge steel, aluminum or thermoformed TPO and polycarbonate, these partitions are designed for maximum impact resistance and uphold a standard of safety set only by Ranger Design products.

Ranger Design partitions also provide a more comfortable environment for the driver by giving more seat travel and by not rattling as the vehicle drives down the road.











Application Guide

Type	Material	 Chevrolet Express Standard Roof	 Ford Transit Low Roof	 Ford Transit Medium Roof	 Ford Transit High Roof	 Ford Transit Connect Standard Roof	 GMC Savana Standard Roof
Clearshield	Composite	-	-	-	-	3520-M P. 35	-
Contoured composite safety partition	Composite	-	-	3310-FTM P. 36	3310-FTH P. 36	-	-
Contoured composite safety partition with window	Composite	-	-	3320-FTM P. 37	3320-FTH P. 37	-	-
Contoured full safety partition	Aluminum	3010-GS P. 42	3010-FTL P. 41	3010-FTM P. 41	3010-FTH P. 41	3010-TC P. 42	3010-GS P. 42
Contoured full safety partition	Steel	C12-H P. 43	C12-FTL P. 42	-	-	C12-E P. 42	C12-H P. 43
Contoured safety partition with perforated window	Steel	C10-H P. 40	C10-FTL P. 39	-	-	C10-E P. 39	C10-H P. 40
Contoured safety partition with window	Aluminum	3020-GS P. 38	3020-FTL P. 38	3020-FTM P. 38	3020-FTH P. 38	3020-TC P. 39	3020-GS P. 38
Contoured wire mesh partition	Steel	-	-	-	-	C13-E P. 43	-
Max View contoured safety partition	Composite	-	3320-FTL P. 34	-	-	3320-TC P. 35	-
Straight mid position safety partition	Aluminum	-	-	-	-	-	-
Straight mid position safety partition with window	Aluminum	-	-	-	-	-	-
Straight partition with perforated window, no access	Steel	C20-GS P. 45	C20-FTL P. 44	C20-FTM P. 45	C20-FTH P. 44	-	C20-GS P. 45
Straight partition with perforated window, swing door	Steel	C30-GS P. 47	C30-FTL P. 46	C30-FTM P. 46	C30-FTH P. 46	-	C30-GS P. 47
Straight partition with window, sliding door	Aluminum	-	-	3068-FTM P. 48	3068-FTH P. 48	-	-
Walk through straight partition	Steel	C24-GS P. 50	C24-FTL P. 50	C24-FTM P. 50	C24-FTH P. 50	-	C24-GS P. 50

VAN PARTITIONS

VAN PARTITIONS

 Mercedes-Benz Metris Standard Roof	 Mercedes-Benz Sprinter Low Roof	 Mercedes-Benz Sprinter High Roof	 Nissan NV Low Roof	 Nissan NV High Roof	 Nissan NV200 Standard Roof	 Ram ProMaster Standard Roof	 Ram ProMaster High Roof	 Ram ProMaster City Standard Roof
3520-M P. 35	-	-	-	-	-	-	-	3520-M P. 35
-	3310-DL P. 35	3310-DH P. 35	-	-	-	3310-RP P. 36	3310-RP P. 36	3310-PC P. 36
-	3320-DL P. 36	3320-DH P. 36	-	-	-	3320-RP P. 37	3320-RP P. 37	-
-	3010-DL P. 41	3010-DH P. 41	-	-	-	3010-RP P. 42	3010-RP P. 42	3010-PC P. 42
-	-	-	-	-	-	-	-	C12-PC P. 43
C10-MM P. 40	-	-	-	-	C10-W P. 40	-	-	C10-PC P. 40
-	3020-DL P. 37	3020-DH P. 37	-	-	-	3020-RP P. 38	3020-RP P. 38	3020-PC P. 38
C13-MM P. 43	-	-	-	-	-	-	-	C13-PC P. 43
3320-MM P. 34	-	-	-	-	-	-	-	-
-	-	3015-DH P. 48	-	-	-	-	-	-
-	-	3025-DH P. 48	-	-	-	-	-	-
-	C20-DL P. 44	C20-DH P. 44	C20-NL P. 45	C20-NH P. 45	-	C20-X P. 45	C20-X P. 45	-
-	C30-DL P. 46	C30-DH P. 46	-	-	-	C30-X P. 47	C30-X P. 47	-
-	3068-DL P. 47	3068-DH P. 47	-	-	-	3068-RP P. 48	3068-RP P. 48	-
-	C24-DL P. 49	C24-DH P. 49	-	-	-	C24-X P. 50	C24-X P. 50	-

VAN PARTITIONS – CONTOURED

VAN PARTITIONS

CONTOURED

CONTOURED MAX VIEW



3320-FTL

Ford Transit
Max View contoured safety partition

Composite

	Low Roof
	50 lbs
	1.5 hr
	Yes
	8"



3320-MM

Mercedes-Benz Metris
Max View contoured safety partition

Composite

	Standard Roof
	48 lbs
	1.2 hrs
	Yes
	9"



3320-PC

Ram ProMaster City
Max view contoured safety partition

Composite

	Standard Roof
	42 lbs
	1 hr
	Yes
	7.1"





3520-M

All Standard Minivans
ClearView germ barrier partition for minivans

Composite

	Standard Minivans
	10 lbs
	0.25 hr
	No
	-

CONTOURED COMPOSITE



3310-DH

Mercedes-Benz Sprinter
Composite contoured safety partition

Composite

	High Roof
	70 lbs
	1 hr
	Yes
	9"



3310-DL

Mercedes-Benz Sprinter
Composite contoured safety partition

Composite

	Low Roof
	65 lbs
	1 hr
	Yes
	9"



3310-GS

Chevrolet Express, GMC Savana
Composite contoured safety partition

Composite

	Standard
	47 lbs
	0.80 hr
	Yes
	9"



3310-FTH

Ford Transit
Composite contoured safety partition

Composite

	High Roof
	66 lbs
	1 hr
	Yes
	9"

VAN PARTITIONS – CONTOURED



3310-FTM

Ford Transit
Composite contoured safety partition

Composite

Medium Roof

63 lbs

1 hr

Yes

9"



3310-PC

Ram ProMaster City
Contoured safety partition

Composite

Standard Roof

44 lbs

1 hr

No

7.1"



3310-RP

Ram ProMaster
Composite contoured safety partition

Composite

Standard/High Roof

64 lbs

1 hr

Yes

9"



3320-DH

Mercedes-Benz Sprinter
Composite contoured safety partition with window

Composite

High Roof

71 lbs

1 hr

No

9"



3320-DL

Mercedes-Benz Sprinter
Composite contoured safety partition with window

Composite

Low Roof

67 lbs

1 hr

No

9"



3320-GS

Chevrolet Express, GMC Savana
Composite contoured safety partition with window

Composite

Standard

48 lbs

0.80 hr

Yes

9"



3320-FTH

Ford Transit

Composite contoured safety partition with window

Composite

High Roof

68 lbs

1 hr

No

9"



3320-FTM

Ford Transit

Composite contoured safety partition with window

Composite

Medium Roof

65 lbs

1 hr

No

9"



3320-RP

RAM ProMaster

Composite contoured safety partition with window

Composite

Standard/High Roof

68 lbs

1 hr

No

9"

CONTOURED WITH WINDOW



3020-DH

Mercedes-Benz Sprinter

Contoured safety partition with window

Aluminum

High Roof

66 lbs

1.2 hrs

No

5.5"



3020-DL

Mercedes-Benz Sprinter

Contoured safety partition with window

Aluminum

Low Roof

64 lbs

1.2 hrs

No

5.5"

VAN PARTITIONS – CONTOURED



3020-FTH

Ford Transit
Contoured safety partition with window

Aluminum

	High Roof
	66 lbs
	1 hr
	Yes
	8.32"



3020-FTL

Ford Transit
Contoured safety partition with window

Aluminum

	Low Roof
	48 lbs
	1 hr
	Yes
	7.16"



3020-FTM

Ford Transit
Contoured safety partition with window

Aluminum

	Medium Roof
	52 lbs
	1 hr
	Yes
	8.32"



3020-GS

Chevrolet Express, GMC Savana
Contoured safety partition with window

Aluminum

	Standard Roof
	49 lbs
	1 hr
	No
	5.56"



3020-PC

Ram ProMaster City
Contoured safety partition with window

Aluminum

	Standard Roof
	41 lbs
	1 hr
	Yes
	8.1"

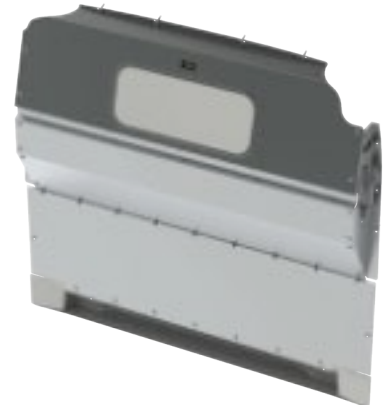

3020-RP

Ram ProMaster
Contoured safety partition with window

Aluminum

	Standard / High Roof
	59 lbs
	1 hr
	Yes
	6.07"

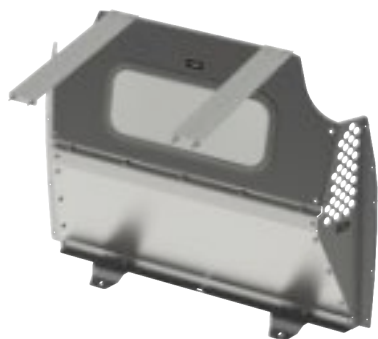

3020-TC

Ford Transit Connect
Contoured safety partition with window

Aluminum

Standard Roof

42 lbs

1 hr

Yes

10.75"

**SETBACK FROM
B PILLAR**

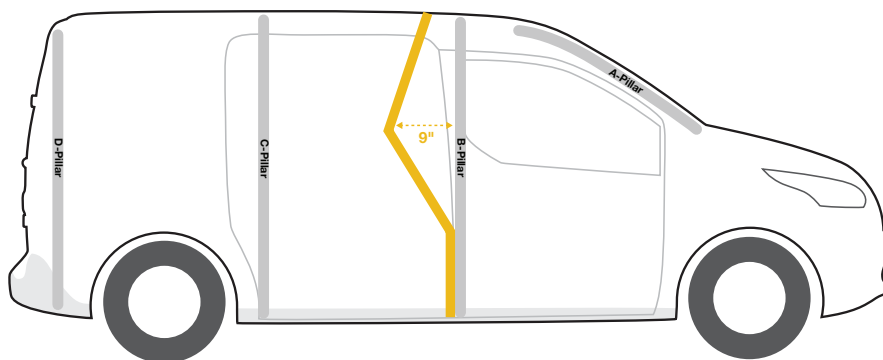

**CONTOURED
WITH
PERFORATED
WINDOW**



C10-E

Ford Transit Connect
Contoured safety partition
with perforated window

Steel

Standard Roof

53 lbs

1 hr

Yes

10.5"



C10-FTL

Ford Transit
Contoured safety partition
with perforated window

Steel

Low Roof

66 lbs

1 hr

Yes

7.11"

VAN PARTITIONS – CONTOURED



C10-H

Chevrolet Express, GMC Savana
Contoured safety partition
with perforated window

Steel

	Standard Roof
	58 lbs
	1 hr
	Yes
	5.56"



C10-MM

Mercedes-Benz Metris
Contoured safety partition
with perforated window

Steel

	Standard Roof
	62 lbs
	1 hr
	Yes
	11"



C10-PC

Ram ProMaster City
Contoured safety partition
with perforated window

Steel

	Standard Roof
	63.3 lbs
	1 hr
	Yes
	8.05"



C10-W

Nissan NV200
Contoured safety partition
with perforated window

Steel

	Standard Roof
	42 lbs
	1 hr
	Yes
	3.5"



CONTOURED FULL PARTITION

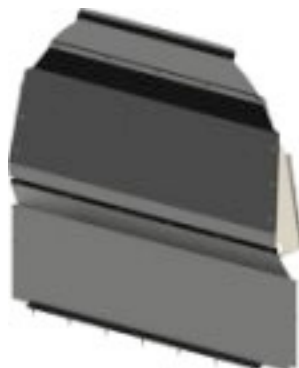

3010-DH

Mercedes-Benz Sprinter
Contoured safety partition

Aluminum

High Roof

59 lbs

1.2 hrs

Yes

5.5"

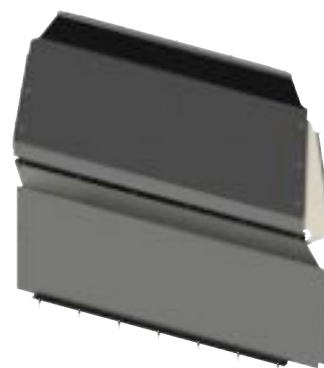

3010-DL

Mercedes-Benz Sprinter
Contoured safety partition

Aluminum

Low Roof

57 lbs

1.2 hrs

No

5.5"



3010-FTH

Ford Transit
Contoured safety partition

Aluminum

High Roof

57 lbs

1 hr

Yes

8.32"



3010-FTL

Ford Transit
Contoured safety partition

Aluminum

Low Roof

46 lbs

1 hr

Yes

7.16"



3010-FTM

Ford Transit
Contoured safety partition

Aluminum

Medium Roof

52 lbs

1 hr

Yes

8.32"

VAN PARTITIONS – CONTOURED

VAN PARTITIONS



3010-GS

Chevrolet Express, GMC Savana
Contoured safety partition

Aluminum

Standard Roof

47 lbs

1 hr

Yes

5.56"



3010-PC

Ram ProMaster City
Contoured safety partition

Aluminum

Standard Roof

39 lbs

1 hr

Yes

8.1"



3010-RP

Ram ProMaster
Contoured safety partition

Aluminum

Standard / High Roof

62.8 lbs

1 hr

Yes

6.07"



3010-TC

Ford Transit Connect
Contoured safety partition

Aluminum

Standard Roof

39.75 lbs

1 hr

Yes

10.75"



C12-E

Ford Transit Connect
Contoured safety partition

Steel

Standard Roof

55 lbs

1 hr

Yes

10.5"



C12-FTL

Ford Transit
Contoured safety partition

Steel

Low Roof

64 lbs

1 hr

Yes

7.11"



C12-H

Chevrolet Express, GMC Savana
Contoured safety partition

Steel

Standard Roof

53 lbs

1 hr

No

5.56"



C12-PC

Ram ProMaster City
Contoured safety partition

Steel

Standard Roof

86 lbs

1 hr

Yes

8.05"

CONTOURED WIRE MESH



C13-E

Ford Transit Connect
Contoured wire mesh partition

Steel

Standard Roof

37 lbs

0.7 hr

Yes

10.5"

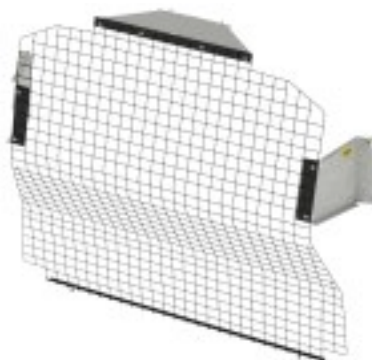

C13-MM

Mercedes-Benz Metris
Contoured wire mesh partition

Steel

Standard Roof

37 lbs

1.2 hrs

Yes

11"



C13-PC

Ram ProMaster City
Contoured wire mesh partition

Steel

Standard Roof

72 lbs

1 hr

Yes

8.33"

VAN PARTITIONS – CONTOURED



STRAIGHT WITH PERFORATED WINDOW — NO ACCESS

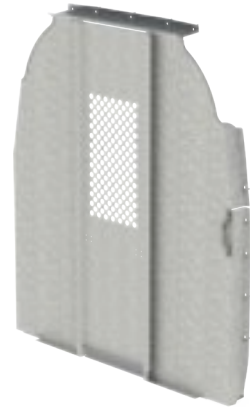

C20-DH

Mercedes-Benz Sprinter

Straight partition with perforated window, no access

Steel

High Roof

89 lbs

1 hr

Yes

7.5"



C20-DL

Mercedes-Benz Sprinter

Straight partition with perforated window, no access

Steel

Low Roof

80 lbs

1 hr

Yes

7.5"



C20-FTH

Ford Transit

Straight partition with perforated window, no access

Steel

High Roof

92.1 lbs

1 hr

Yes

4.76"



C20-FTL

Ford Transit

Straight partition with perforated window, no access

Steel

Low Roof

64 lbs

1 hr

Yes

4.25"



C20-FTM

Ford Transit

Straight partition with perforated window, no access

Steel

Medium Roof

77 lbs

1 hr

Yes

4.76"



C20-GS

Chevrolet Express, GMC Savana

Straight partition with perforated window, no access

Steel

Standard Roof

61 lbs

1.5 hr

Yes

6.75"



C20-NH

Nissan NV

Straight partition with perforated window, no access

Steel

High Roof

80 lbs

1.5 hrs

Yes

5.5"



C20-NL

Nissan NV

Straight partition with perforated window, no access

Steel

Low Roof

58 lbs

1 hr

Yes

5.5"

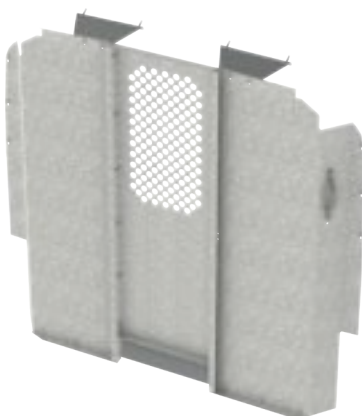

C20-X

Ram ProMaster

Straight partition with perforated window, no access

Steel

Standard / High Roof

78 lbs

1 hr

Yes

6.24"



VAN PARTITIONS – STRAIGHT

VAN PARTITIONS

STRAIGHT WITH PERFORATED WINDOW — SWING DOOR



C30-DH

Mercedes-Benz Sprinter
Straight partition with perforated window, swing door

Steel

High Roof

92 lbs

1 hr

No

8"



C30-DL

Mercedes-Benz Sprinter
Straight partition with perforated window, swing door

Steel

Low Roof

83 lbs

1 hr

No

8"



C30-FTH

Ford Transit
Straight partition with perforated window, swing door

Steel

High Roof

86 lbs

1.5 hrs

Yes

4.96"



C30-FTL

Ford Transit
Straight partition with perforated window, swing door

Steel

Low Roof

68 lbs

1.5 hrs

Yes

4.61"



C30-FTM

Ford Transit
Straight partition with perforated window, swing door

Steel

Medium Roof

79 lbs

1.5 hrs

Yes

4.96"



C30-GS

Chevrolet Express, GMC Savana
Straight partition with perforated window, swing door

Steel

Standard Roof

63.2 lbs

1 hr

Yes

6.75"

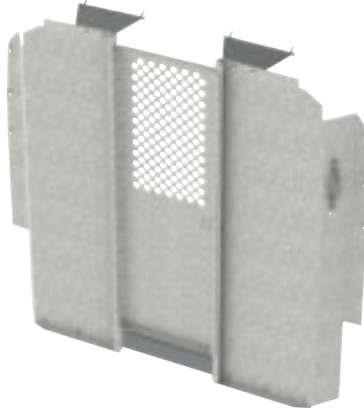

C30-X

Ram ProMaster
Straight partition with perforated window, swing door

Steel

Standard / High Roof

80 lbs

1 hr

Yes

6.24"



STRAIGHT WITH WINDOW — SLIDING DOOR



3068-DH

Mercedes-Benz Sprinter
Straight partition with window, sliding door

Aluminum

High Roof

97.9 lbs

1.5 hrs

Yes

8"



3068-DL

Mercedes-Benz Sprinter
Straight partition with window, sliding door

Aluminum

Low Roof

84 lbs

1.5 hrs

Yes

7.25"

VAN PARTITIONS – STRAIGHT

VAN PARTITIONS



3068-FTH

Ford Transit

Straight partition with window, sliding door

Aluminum

High Roof

77 lbs

1.5 hrs

Yes

6.29"



3068-FTM

Ford Transit

Straight partition with window, sliding door

Aluminum

Medium Roof

75 lbs

1.5 hrs

Yes

6.29"



3068-RP

Ram ProMaster

Straight partition with window, sliding door

Aluminum

Standard / High Roof

76 lbs

1.5 hrs

Yes

6.26"

STRAIGHT MID POSITION



3015-DH

Mercedes-Benz Sprinter

Mid position straight safety partition

Aluminum

High Roof

59 lbs

1.2 hrs

No

2.5"



3025-DH

Mercedes-Benz Sprinter

Mid position straight safety partition with window

Aluminum

High Roof

66 lbs

1.2 hrs

No

2.5"

ACCESSORIES



3024

Universal
Partition window with frame
for 3010

Aluminum

Universal
5 lbs
0.2 hr
No

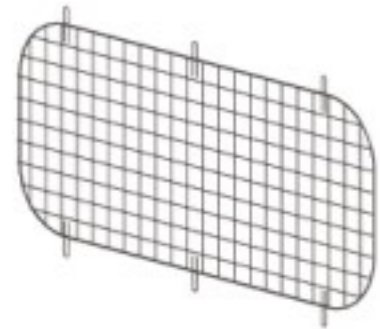

3044

Universal
Grill for partition window
for 3020, 3025, 3068

Steel

Universal
2 lbs
0.5 hr
No

WALK THROUGH



C24-DH

Mercedes-Benz Sprinter
Straight walk through partition

Steel

High Roof
66 lbs
1 hr
No
7.5"



C24-DL

Mercedes-Benz Sprinter
Straight walk through partition

Steel

Low Roof
61 lbs
1 hr
No
7.5"

VAN PARTITIONS – STRAIGHT



C24-FTH

Ford Transit
Straight walk through partition

Steel

High Roof
65 lbs
1.2 hrs
Yes
4.76"



C24-FTL

Ford Transit
Straight walk through partition

Steel

Low Roof
48 lbs
1.2 hrs
Yes
4"



C24-FTM

Ford Transit
Straight walk through partition

Steel

Medium Roof
58 lbs
1.2 hrs
Yes
4.76"



C24-GS

Chevrolet Express, GMC Savana
Straight walk through partition

Steel

Standard Roof
46.5 lbs
1 hr
Yes
6.75"



C24-X

Ram ProMaster
Straight walk through partition

Steel

Standard / High Roof
70 lbs
1 hr
Yes
6.24"



VAN PARTITIONS – STRAIGHT

