



SECURE EVERY CHALLENGE™



TRUCK STORAGE EQUIPMENT

THE FUTURE OF TRUCK BOXES IS HERE.



weather guard[®]

Your truck and tools are everything to your livelihood. That's why real pros know there's only one name they can trust, WEATHER GUARD[®]. The new line of WEATHER GUARD[®] truck boxes convert your truck into a sleek mobile fortress, with superior anti-theft construction and locks able to withstand any weather condition or attempted theft.

SECURE EVERY CHALLENGE.[™]

WEATHERGUARD.COM

TABLE OF CONTENTS

TRUCK BOX FIT GUIDE 4

WEATHER GUARD® TRUCK BOXES 6

Saddle Boxes 6

Lo-Side Boxes 8

Hi-Side Boxes 10

Super-Side Boxes 12

Gull Wing Boxes 13

PowerSync™ 14

Fit Up Ordering Scenarios 16

All-Purpose Chests 18

Wheel Well Boxes 20

Truck Box Accessories 21

IN-BED STORAGE SOLUTIONS 22

PACK RAT® Drawer Units 22

Transfer Tanks/Accessories 25

UNDERBED BOXES 27

Steel Underbed Boxes 27

Aluminum Underbed Boxes 28

BED-RAIL MOUNTED SOLUTIONS 29

Steel Truck Rack 29

Service Body Ladder Racks 31

WEEKENDER® Truck Rack 32

Mounting Accessories 34

Truck Rack Fit Guide 35

Configurations Guide 36

CODING THE LOCKS* EASY 3-STEP GUIDE

1 START

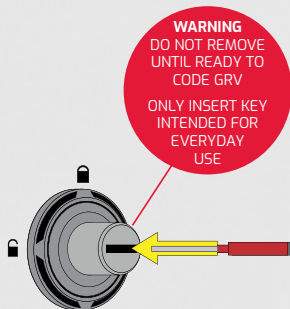

Read, then remove label, open box lid, then fully insert key.



IMPORTANT:

Once a lock is coded, it **cannot** be changed. Make sure to register your key code.

2

CODING THE LOCK

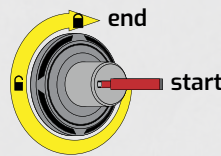

Turn key clockwise a full 3 quarters of a circle

USEFUL HINT:

When the key is coding, there will be a 'clicking' sound.

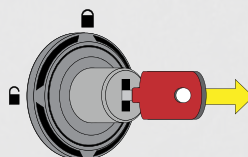

The box is now **permanently** coded. Remove key.

3

TESTING THE LOCK

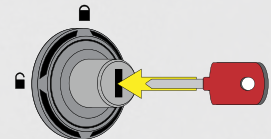

Fully insert key again.

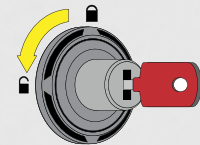

Turn key counter-clockwise 1/4 turn to lock.

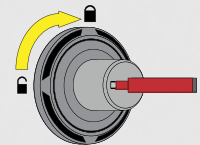

Turn key clockwise 1/4 turn to lock.

USEFUL HINT:

Lock and unlock the boxes 5 times to ensure it works. Remove key full between each test.

* For -03 Saddles & Lo-Sides Only

TRUCK BOX FIT GUIDE

Aluminum Boxes available in Brite White, Clear or Gloss Black ARMOR TUF® Powder Coat.

Steel Boxes available in Brite White and Textured Black ARMOR TUF® Powder Coat.

Coating Choice Options: X=0 (Clear) or X=3 (Brite White) or X=5 (Gloss Black) or X=6 (Gunmetal Gray) or X=52 (Textured Black).

Not all coating choices available on all models.

| | | | 5' BED | 6' BED | 5½' BED | 6½' BED | 8' BED | 5½' BED | 6' BED | 8' BED | 5' BED | 6' BED | 5½' BED | 6½' BED | 8' BED |
|-----------------------|----------|----------|--------------------|------------------------------------|---------|---------|--------------------------|---------|--------|-------------|--------|------------|---------|---------|--------|
| SADDLE BOXES | ALUM | STEEL | CHEVROLET COLORADO | CHEVROLET SILVERADO 1500/2500/3500 | | | DODGE RAM 1500/2500/3500 | | | FORD RANGER | | FORD F150* | | | |
| FULL-SIZE EXTRA WIDE | | 116-X-03 | | | • | • | • | • | • | • | | | • | • | • |
| | 117-X-03 | | | | • | • | • | • | • | • | | | • | • | • |
| FULL-SIZE DEEP | | 128-X-03 | | | • | • | | | | • | | | | • | • |
| | 123-X-03 | | | | • | • | | | | • | | | | • | • |
| FULL-SIZE STANDARD | | 126-X-03 | | | • | • | • | • | • | • | | | • | • | • |
| | 127-X-03 | | | | • | • | • | • | • | • | | | • | • | • |
| FULL-SIZE LOW-PROFILE | | 120-X-03 | | | • | • | • | •† | • | • | | | • | • | • |
| | 121-X-03 | | | | • | • | • | •† | • | • | | | • | • | • |
| COMPACT - DEEP | 137-X-03 | | • | • | | | | | | | • | • | | | |
| COMPACT - STANDARD | | 156-X-03 | • | • | | | | | | | • | • | | | |
| | 154-X-03 | | • | • | | | | | | | • | • | | | |
| COMPACT - LOW-PROFILE | 131-X-03 | | • | • | | | | | | | • | • | | | |
| GULL WING BOXES | | | | | | | | | | | | | | | |
| FULL-SIZE EXTRA WIDE | | 115-3-01 | | | • | • | • | • | • | • | | | • | • | • |
| | 114-X-01 | | | | • | • | • | • | • | • | | | • | • | • |
| FULL-SIZE STANDARD | | 125-X-01 | | | • | • | • | • | • | • | | | • | • | • |
| | 124-X-01 | | | | • | • | • | • | • | • | | | • | • | • |
| ALL-PURPOSE CHESTS | | | | | | | | | | | | | | | |
| COMPACT | | 645-X-01 | • | • | • | • | • | • | • | • | • | • | • | • | • |
| | 644-X-01 | | • | • | • | • | • | • | • | • | • | • | • | • | • |
| FULL/COMPACT | | 655-3-01 | | | • | • | | | | • | | | | • | • |
| | 654-X-01 | | | | • | • | | | | • | | | | • | • |
| FULL-SIZE STANDARD | | 665-X-01 | | | • | • | | | | • | | | | | • |
| | 664-X-01 | | | | • | • | | | | • | | | | | • |
| FULL/COMPACT | | 675-3-01 | | | • | • | • | | • | • | | | • | • | • |
| | 674-X-01 | | | | • | • | • | | • | • | | | • | • | • |
| FULL-SIZE EXTRA WIDE | | 685-3-01 | | | | | | | | • | | | | | • |
| | 684-X-01 | | | | | | | | | • | | | | | • |

* Newer truck models available with aluminum beds are compatible with the WEATHER GUARD® truck boxes and chests in the table. Follow installation instructions for mounting to aluminum beds and use mounting components included with the truck box.

† Does not fit Ram Classic or 2018 & older models



NOTE: THIS GUIDE APPLIES TO 2018 OR NEWER MODEL YEAR VEHICLES.
 YOU SHOULD MEASURE YOUR VEHICLE TO MAKE SURE YOUR WEATHER GUARD® TRUCK BOX WILL FIT.

| 6¾' BED | 8' BED | 5' BED | 6' BED | 5½' BED | 6½' BED | 8' BED | 5' BED | 6' BED | 5½' BED | 6½' BED | 8' BED | 5' BED | 6' BED | 5½' BED | 6½' BED | 8' BED |
|-----------------------------|--------|------------|--------|---------------------------|---------|--------|-----------------|--------|--------------|---------|--------|---------------|--------|---------------|---------|--------|
| FORD SUPER DUTY F-250/F-350 | | GMC CANYON | | GMC SIERRA 1500/2500/3500 | | | NISSAN FRONTIER | | NISSAN TITAN | | | TOYOTA TACOMA | | TOYOTA TUNDRA | | |
| • | • | | | • | • | • | | | • | • | • | | | • | • | • |
| • | • | | | • | • | • | | | • | • | • | | | • | • | • |
| • | • | | | | • | • | | | • | • | • | | | • | • | • |
| • | • | | | | • | • | | | • | • | • | | | • | • | • |
| • | • | | | • | • | • | | | • | • | • | | | • | • | • |
| • | • | | | • | • | • | | | • | • | • | | | • | • | • |
| • | • | | | • | • | • | | | • | • | • | | | • | • | • |
| | | • | • | | | | • | • | | | | | | | | |
| | | • | • | | | | • | • | | | | | | | | |
| | | • | • | | | | • | • | • | • | | | | | | |

| | | | | | | | | | | | | | | | | |
|---|---|--|--|---|---|---|--|--|---|---|---|--|--|---|---|---|
| • | • | | | • | • | • | | | • | • | • | | | | | • |
| • | • | | | • | • | • | | | • | • | • | | | | | • |
| • | • | | | • | • | • | | | • | • | • | | | • | • | • |
| • | • | | | • | • | • | | | • | • | • | | | • | • | • |

| | | | | | | | | | | | | | | | | |
|---|---|---|---|---|---|---|---|---|---|---|---|--|--|---|---|---|
| • | • | • | • | • | • | • | • | • | • | • | | | | • | • | • |
| • | • | • | • | • | • | • | • | • | • | • | | | | • | • | • |
| • | • | | | | • | • | | | • | • | | | | | | • |
| • | • | | | | • | • | | | • | • | | | | | | • |
| | | | | | • | • | | | | | | | | | | • |
| | | | | | • | • | | | | | | | | | | • |
| • | • | | | • | • | • | | | • | • | • | | | | • | • |
| • | • | | | • | • | • | | | • | • | • | | | | • | • |
| | | | | | | | | | | | • | | | | | • |
| | | | | | | | | | | | • | | | | | • |

UNMATCHED PROTECTION SADDLE BOXES



1 One Key Simplicity

3 Enhanced Tie Down Buckles

2 High Security Locking System

7 PowerSync™ Compatible

THE ULTIMATE IN PROTECTION

Maximum Durability

- 1 ONE KEY SIMPLICITY** Code multiple boxes on a truck or entire fleet to the same key
- 2 HIGH SECURITY LOCKING SYSTEM** Improved security provides unmatched protection
- 3 ENHANCED TIE DOWN BUCKLES** Offer a larger clearance for universal or multiple straps
- 4 EASIER TO USE** Less force to close and an optimized latching system
- 5 UPGRADED INSTALLATION HARDWARE** Easier to install
- 6 SLEEK NEW DESIGN** New lid profile & introducing the new Gunmetal Gray color
- 7 POWERSYNC™ COMPATIBLE** Easy-to-install PowerSync interior truck box lights and remote keyless entry (RKE) available (sold separately)

LIFETIME LIMITED WARRANTY



WEATHER GUARD® IS THE ULTIMATE IN PROTECTION OF SADDLE BOXES

Like you, WEATHER GUARD® Saddle Boxes keep getting better and better. Now with more options and features than ever. Like industry-leading security with our exclusive tamper-resistant EXTREME PROTECTION™ LOCK. WEATHER GUARD® Saddle Boxes are the most popular truck storage option due to ease of installation, maximum bed clearance, and of course legendary durability. Constructed of either steel or aluminum diamond plate and finished with an ARMOR TUF® Powder Coat in Clear, Gloss Black, or Textured Black that lasts for years and looks great.

ALUMINUM DIAMOND PLATE

-  Clear ARMOR TUF® Powder Coat
-  Textured Matte Black ARMOR TUF® Powder Coat
-  Gloss Black ARMOR TUF® Powder Coat
-  Gunmetal Gray ARMOR TUF® Powder Coat

STEEL

-  Brite White ARMOR TUF® Powder Coat
-  Gloss Black ARMOR TUF® Powder Coat

Choice Options: X = 0 (Clear) or X = 3 (Brite White) or X = 5 (Gloss Black) or X = 52 (Textured Matte Black) or X = 6 (Gunmetal Gray)

INTEGRATED FEATURES

Sliding Steel Tray

PowerSync™ - Automotive Grade Connectors, Optimal Visibility, Impact Resistant Housing, Quick Connect, Automatic Switch

See page 14





FULL-SIZE STANDARD

ALUMINUM 10.5 CUBIC FEET

- 127-0-03 127-52-03
- 127-5-03 127-6-03

Ship Weight: 84 Lbs.

STEEL 10.6 CUBIC FEET

- 126-3-03
- 126-5-03

Ship Weight: 143 Lbs.



FULL-SIZE EXTRA WIDE

ALUMINUM 14.4 CUBIC FEET

- 117-0-03 117-52-03
- 117-5-03 117-6-03

Ship Weight: 102 Lbs.

STEEL 14.5 CUBIC FEET

- 116-3-03
- 116-5-03

Ship Weight: 168 Lbs.



FULL-SIZE LOW PROFILE

ALUMINUM 10.2 CUBIC FEET

- 121-0-03 121-52-03
- 121-5-03 121-6-03

Ship Weight: 120 Lbs.

STEEL 10.6 CUBIC FEET

- 120-3-03
- 120-5-03

Ship Weight: 127 Lbs.



FULL-SIZE EXTRA DEEP

ALUMINUM 14.2 CUBIC FEET

- 123-0-03 123-52-03
- 123-5-03 123-6-03

Ship Weight: 90 Lbs.

STEEL 14.3 CUBIC FEET

- 128-3-03
- 128-5-03

Ship Weight: 156 Lbs.



COMPACT STANDARD

ALUMINUM 6.0 CUBIC FEET

- 154-0-03 154-52-03
- 154-5-03 154-6-03

Ship Weight: 74 Lbs.

STEEL 6.1 CUBIC FEET

- 156-3-03
- 156-5-03

Ship Weight: 120 Lbs.



COMPACT LOW-PROFILE

ALUMINUM 7.7 CUBIC FEET

- 131-0-03 131-52-03
- 131-5-03 131-6-03

Ship Weight: 74 Lbs.



COMPACT DEEP

ALUMINUM 8.0 CUBIC FEET

- 137-0-03 137-52-03
- 137-5-03 137-6-03

Ship Weight: 77 Lbs.

UNMATCHED PROTECTION LO-SIDE BOXES



LO-SIDE BOXES KEY FEATURES

- 1 ONE KEY SIMPLICITY** Code multiple boxes on a truck or entire fleet to the same key
- 2 HIGH SECURITY LOCKING SYSTEM** Improved security provides unmatched protection
- 3 ENHANCED TIE DOWN BUCKLES** Offer a larger clearance for universal or multiple straps
- 4 EASIER TO USE** Less force to close and an optimized latching system
- 5 UPGRADED INSTALLATION HARDWARE** Easier to install
- 6 SLEEK NEW DESIGN** New lid profile & introducing the new Gunmetal Gray color
- 7 POWERSYNC™ COMPATIBLE** Easy-to-install Powersync interior truck box lights and remote keyless entry (RKE) available (sold separately)

3 Enhanced Tie Down Buckles



2 High Security Locking System



7 PowerSync™ Compatible

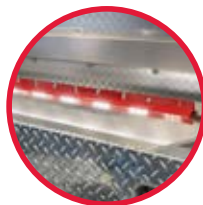

LIFETIME LIMITED WARRANTY

QUICK ACCESS FROM THE BEDRAILS

WEATHER GUARD® Lo-Side Boxes mount over the bedrails of your truck and keep critical tools and parts at your fingertips. Their easy installation utilizes mounting brackets that do not require drilling into the rails. The design and location on the truck bed aren't the only attributes that keep you productive—you can get inside with just one hand using an automotive-style latch. The durable Lo-Side is available in steel, and protected by an ARMOR TUF® Powder Coat finish in either Brite White or Gloss Black, or diamond plate aluminum (Clear, Brite White, Gloss Black, and Textured Black). The Lo-Side from WEATHER GUARD® can also be used separately or in combination with Cross Boxes or Saddle Boxes.

ALUMINUM DIAMOND PLATE



Clear ARMOR TUF® Powder Coat



Textured Matte Black ARMOR TUF® Powder Coat



Gloss Black ARMOR TUF® Powder Coat



Gunmetal Gray ARMOR TUF® Powder Coat

STEEL



Brite White ARMOR TUF® Powder Coat



Gloss Black ARMOR TUF® Powder Coat

Choice Options: X = 0 (Clear) or X = 3 (Brite White) or X = 5 (Gloss Black) or X = 52 (Textured Matte Black) or X = 6 (Gunmetal Gray)

INTEGRATED FEATURES

PowerSync™ - Automotive Grade Connectors, Optimal Visibility, Impact Resistant Housing, Quick Connect, Automatic Switch

[See page 14](#)





41" LOW PROFILE

ALUMINUM 3.8 CUBIC FEET

- 180-0-03 180-52-03
- 180-5-03 180-6-03

Ship Weight: 42 Lbs.

ALUMINUM
STEEL

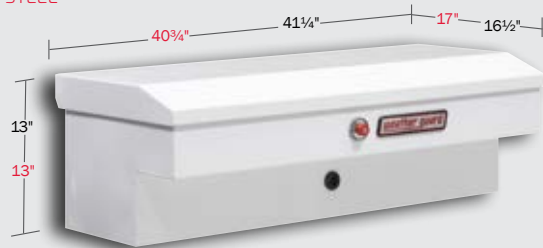

41" STANDARD

ALUMINUM 3.0 CUBIC FEET

- 184-0-03 184-52-03
- 184-5-03 184-6-03

Ship Weight: 42 Lbs.

STEEL 3.0 CUBIC FEET

- 185-3-03
- 185-5-03

Ship Weight: 63.5 Lbs.

NOTE: This product has different dimensions for ALUMINUM and STEEL.

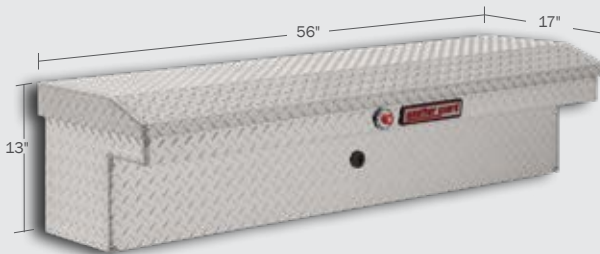

56" LOW PROFILE

ALUMINUM 3.8 CUBIC FEET

- 178-0-03 178-52-03
- 178-5-03 178-6-03

Ship Weight: 48 Lbs.

ALUMINUM
STEEL



56" STANDARD

ALUMINUM 4.1 CUBIC FEET

- 174-0-03 174-52-03
- 174-5-03 174-6-03

Ship Weight: 49 Lbs.

STEEL 4.2 CUBIC FEET

- 175-3-03
- 175-5-03

Ship Weight: 79.5 Lbs.

NOTE: This product has different dimensions for ALUMINUM and STEEL.

ALUMINUM
STEEL



87" STANDARD

ALUMINUM 6.5 CUBIC FEET

- 164-0-03 164-52-03
- 164-5-03 164-6-03

Ship Weight: 65.5 Lbs.

STEEL 6.6 CUBIC FEET

- 165-3-03
- 165-5-03

Ship Weight: 114 Lbs.

NOTE: This product has different dimensions for ALUMINUM and STEEL.

UNMATCHED PROTECTION HI-SIDE BOXES

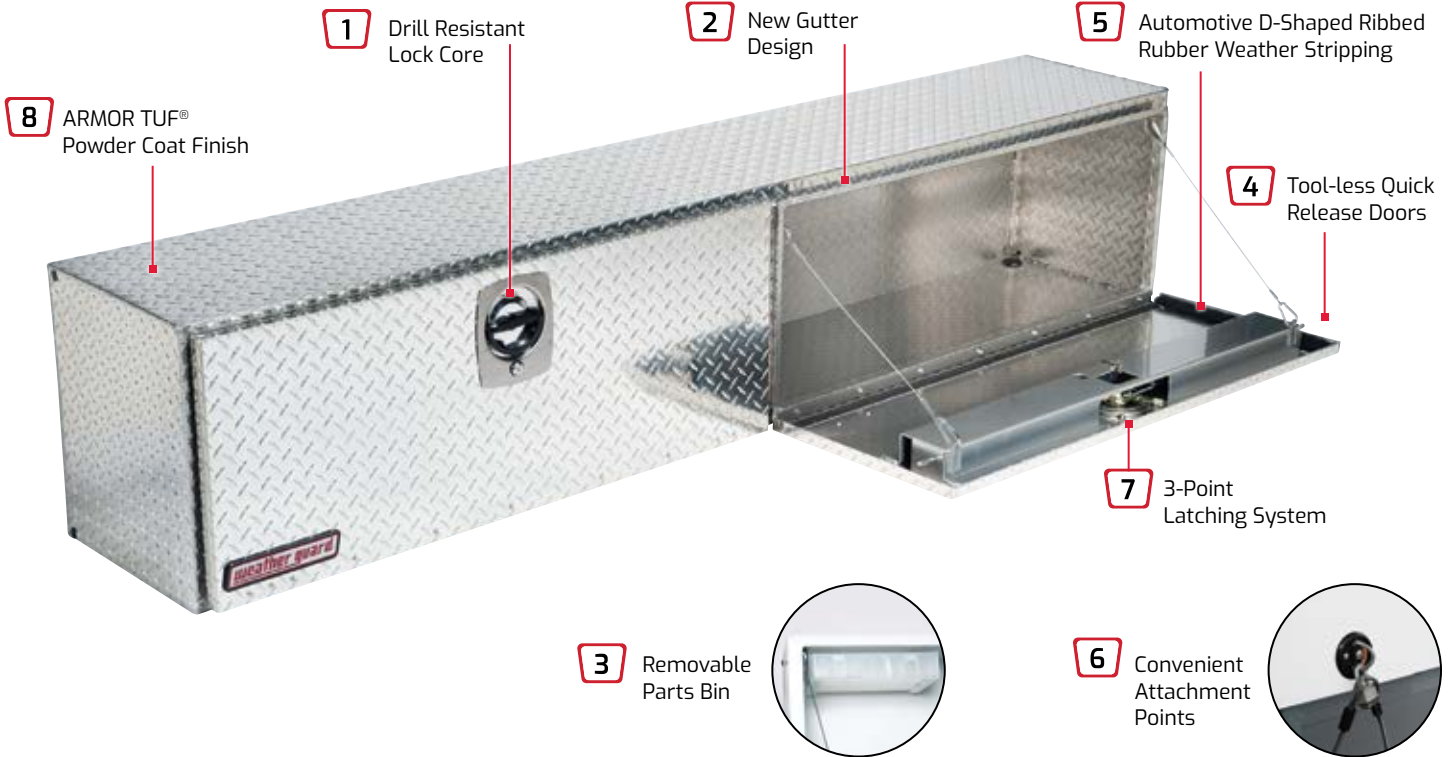

LIFETIME LIMITED WARRANTY

ADDING STORAGE WHILE PRESERVING BED SPACE

Even the best can get better. That's why we keep pushing our engineers to top themselves. And so they have. Now our class-leading WEATHER GUARD® Hi-Side Truck Boxes deliver even greater protection from the elements, from vandalism. WEATHER GUARD® Hi-Sides are built to outlast the competition, just like you—hard-working construction pros, skilled tradespeople, field service and municipal workers who need quick access to valuable tools, equipment and parts while keeping the truck bed open for supplies. You never stop. Neither do we.

WARNING

Hi-Side Boxes cannot be installed to truck racks. Support legs included with box is required for installation.

HI-SIDE
5.6 CUBIC FEET



- ALUMINUM
- 346-0-02
- 346-5-02
- Ship Weight: 45 Lbs.

- STEEL
- 246-3-02
- Ship Weight: 76 Lbs.

Door Opening Measures:
12 3/4"H x 42"W

HI-SIDE
7.9 CUBIC FEET



- ALUMINUM
- 364-0-02
- 364-5-02
- Ship Weight: 60 Lbs.

- STEEL
- 264-3-02
- Ship Weight: 101 Lbs.

Door Opening Measures:
12 3/4"H x 29"W

HI-SIDE BOXES KEY FEATURES

- 1** Drill resistant lock core helps protect against break-ins
- 2** Gutter design channels rain and snow off box to keep contents dry
- 3** Removable parts bin keeps small items organized
- 4** Tool-less quick release doors adjust from 90° to 180° with QuickClips, no tools required
- 5** Automotive D-Shaped Ribbed Rubber Weather Stripping keeps its shape even after years of service
- 6** Convenient attachment point secures materials and tools in pickup bed
- 7** 3-Point Latching System helps protect against theft and weather
- 8** ARMOR TUF® Powder Coat Protection

RECOMMENDED ACCESSORIES

Adjustable Shelf
Accessory (pg. 21)



HI-SIDE
8.9 CUBIC FEET



ALUMINUM
 372-0-02
 372-5-02
 Ship Weight: 64 Lbs.
Door Opening Measures:
 12 3/4"H x 33"W

HI-SIDE
8.9 CUBIC FEET



STEEL
 272-3-02
 Ship Weight: 109 Lbs.
Door Opening Measures:
 12 3/4"H x 33"W

HI-SIDE
11.1 CUBIC FEET



ALUMINUM
 390-0-02
 390-5-02
 Ship Weight: 74 Lbs.
Door Opening Measures:
 12 3/4"H x 42"W

HI-SIDE
11.1 CUBIC FEET



STEEL
 290-3-02
 Ship Weight: 129 Lbs.
Door Opening Measures:
 12 3/4"H x 42"W

HI-SIDE
11.8 CUBIC FEET



ALUMINUM
 396-0-02
 396-5-02
 Ship Weight: 79 Lbs.
Door Opening Measures:
 12 3/4"H x 45"W

HI-SIDE
11.8 CUBIC FEET



STEEL
 296-3-02
 Ship Weight: 136 Lbs.
Door Opening Measures:
 12 3/4"H x 45"W



UNMATCHED PROTECTION SUPER-SIDE BOXES

SUPER-SIZE YOUR STORAGE



Super-Side versions of the WEATHER GUARD® Hi-Side are available—whether you choose the steel or diamond plate aluminum version—with all of the same features that the Hi-Sides offer. A Super-Side version of the steel Hi-Side is available, providing an extra 2 inches of height and 3 inches of depth. A Jumbo Super-Side version of the steel Hi-Side is also available, with 6 more inches of width and 6 more inches of height for a whopping 21.4 cubic feet capacity. An extra-large Super-Side version of the aluminum Hi-Side is available, too, with an extra 2 inches of height and 3 inches of depth.

LIFETIME LIMITED WARRANTY

ALUMINUM DIAMOND PLATE

-  Gloss Black ARMOR TUF® Powder Coat
-  Clear ARMOR TUF® Powder Coat
-  Textured Matte Black ARMOR TUF® Powder Coat

STEEL



-  Brite White ARMOR TUF® Powder Coat
-  Gloss Black ARMOR TUF® Powder Coat

Choice Options:

- X = 0 (Clear) or
- X = 3 (Brite White) or
- X = 5 (Gloss Black) or
- X = 52 (Textured Black)

SUPER-SIDE 7.7 CUBIC FEET





- ALUMINUM**
-  347-0-02
-  347-5-02
- Ship Weight: 50 Lbs.
- STEEL**
-  247-3-02
- Ship Weight: 86 Lbs.

Door Opening Measures:
14 3/4"H x 42"W

SUPER-SIDE 10.8 CUBIC FEET







- ALUMINUM**
-  365-0-02
-  365-5-02
- Ship Weight: 65 Lbs.
- STEEL**
-  265-3-02
- Ship Weight: 114 Lbs.

Door Opening Measures:
14 3/4"H x 29"W

SUPER-SIDE 15.2 CUBIC FEET



- ALUMINUM**
-  391-0-02
-  391-5-02
-  391-52-02
- Ship Weight: 83 Lbs.
- STEEL**
-  291-3-02
- Ship Weight: 147 Lbs.

Door Opening Measures:
14 3/4"H x 42"W

JUMBO SUPER-SIDE 21.4 CUBIC FEET



- STEEL**
-  297-3-02
- Ship Weight: 174 Lbs.
- Door Opening Measures:
20 3/4"H x 45"W

UNMATCHED PROTECTION GULL WING BOXES

GULL WING BOX KEY FEATURES

- 1** **EXTREME PROTECTION™ LOCK**
tamper-resistant retracting lock helps protect against break-ins
- 2** **Two independent covers**
access from either side of truck
- 3** **Dual Stage Automotive Rotary Latch and Heavy Duty Looped Strikers**
provide extreme security
- 4** **Heavy Duty C-Channel Reinforced Lid Construction**
for maximum durability
- 5** **Automotive D-Shaped Ribbed Rubber Weather Stripping**
keep its shape even after years of service
- 6** **ARMOR TUF® Powder Coat Protection**
- 7** **Heavy Gauge Five Piece Welded Construction**
puts strength where it is needed most



LIFETIME LIMITED WARRANTY

FULL-SIZE STANDARD 11.3 CUBIC FEET

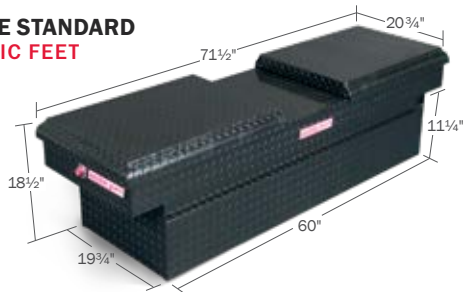

- ALUMINUM**
- 124-0-01
 - 124-5-01
- Ship Weight: 78 Lbs.
- STEEL**
- 125-3-01
 - 125-5-01
- Ship Weight: 122 Lbs.

FULL-SIZE EXTRA WIDE 15.3 CUBIC FEET



- ALUMINUM**
- 114-0-01
 - 114-5-01
- Ship Weight: 92 Lbs.
- STEEL**
- 115-3-01
- Ship Weight: 150 Lbs.

QUICK ACCESS FROM EITHER SIDE OF THE TRUCK BED

WEATHER GUARD® Gull Wing Boxes allow access from either side of the truck with two independent covers. A productivity-aiding plus is an automotive-style latch that allows you to pop each cover open with one hand. These rugged, versatile boxes are available in steel with a Brite White or Gloss Black ARMOR TUF® Powder Coat, or in aluminum diamond plate (Clear or Gloss Black) and a full weather seal keeps out the elements. Gull Wing Boxes can be used in combination with Lo-Side or Super-Lo Boxes for even more storage.

UNMATCHED PROTECTION TRUCK BOX ACCESSORIES



INTERIOR LIGHTS & REMOTE KEYLESS ENTRY

PowerSync™ Interior Truck Box Lights

- 1** Automotive grade connectors – Professional grade protection from dust and water
- 2** Optimal Visibility – Long life LED, 160° coverage of full box, reduced glare
- 3** Impact resistant housing – Designed to withstand items shifting in the box
- 4** Quick connect – 30 minutes or less easy install harness
- 5** Automatic switch – Only powers on when truck box is open

Remote Keyless Entry (RKE)

- 6** Control up to Three Boxes – Using the same Key Fob
- 7** Quick Connect, Easy Install – 30 min or less with no cutting or splicing
- 8** No more hassling with keys – Key FOB can be used on locked boxes

Open Truck Boxes with a maximum proximity of 25 feet

PowerSync™ Interior Truck Box Lighting & RKE Capability

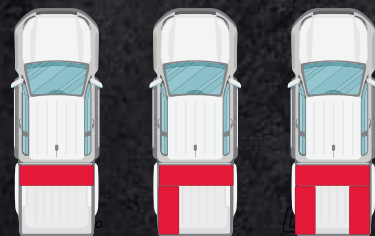









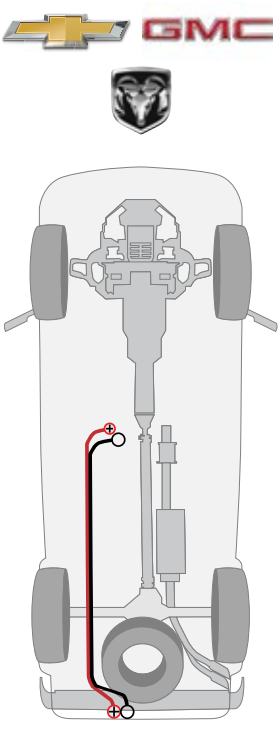



NOTE: Compatible with -03 Saddle & Lo-Side Truck Boxes

PRODUCT OFFERING

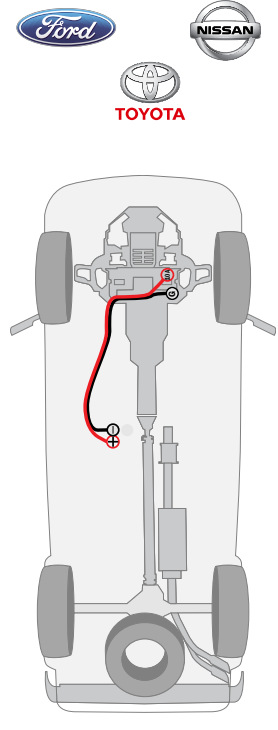
| Part No. | Description |
|-----------------------------------|--------------------------------------|
| REMOTE KEYLESS ENTRY (RKE) | |
| PS8000 | Saddle Box RKE |
| PS8001 | Lo-Side RKE |
| PS8002 | Lo-Side Extension RKE |
| PS8003 | Saddle RKE Kit – Hitch |
| PS8004 | Saddle RKE Kit – Fuse |
| INTERIOR TRUCK BOX LIGHTS | |
| PS8100 | Full Size Saddle Lights Bezel |
| PS8101 | Compact Saddle/Lo-Sides Lights Bezel |
| PS8102 | Long Lo-Sides (164/165) Lights Bezel |
| PS8103 | Full Size Saddle Lights Kit – Hitch |
| PS8104 | Full Size Saddle Lights Kit – Fuse |
| ACCESSORIES | |
| PS8400 | Hitch Wire Harness |
| PS8401 | Fuse Box Wire Harness |
| PS8402 | 4 Way Wiring Plug Connector |
| PS8403 | 7' Wire Extension |
| PS8404 | 15' Wire Extension |
| PS8405 | Key FOB |

STARTER KIT *Includes wiring harness*

| STEP ONE | STEP TWO | STEP THREE | | | | | |
|--|---|--|--|--|-------------------|--|---|
| <p>Choose Vehicle OEM</p>  <p>HITCH CONNECTION</p> | <p>Choose Truck Size & Corresponding Saddle</p> <p>FULL SIZE Saddle</p>  <table border="1" data-bbox="406 483 779 609"> <tr> <td>For Truck Models:</td> <td>116-X-03 120-X-03 123-X-03 127-X-03</td> <td>117-X-03 121-X-03 126-X-03 128-X-03</td> </tr> </table> <p>COMPACT Saddle</p>  <table border="1" data-bbox="406 924 779 1050"> <tr> <td>For Truck Models:</td> <td>131-X-03 137-X-03 154-X-03 156-X-03</td> </tr> </table> | For Truck Models: | 116-X-03 120-X-03 123-X-03 127-X-03 | 117-X-03 121-X-03 126-X-03 128-X-03 | For Truck Models: | 131-X-03 137-X-03 154-X-03 156-X-03 | <p>PowerSync™ Accessories</p> <p>LIGHTS PS8103</p>  <p>REMOTE KEYLESS ENTRY PS8003</p>  <p>LIGHTS</p> <p>NO COMPACT SADDLE LIGHTS STARTER KITS AVAILABLE. PLEASE REFERENCE EXPANSION OPTIONS.</p> <p>REMOTE KEYLESS ENTRY PS8003</p>  |
| For Truck Models: | 116-X-03 120-X-03 123-X-03 127-X-03 | 117-X-03 121-X-03 126-X-03 128-X-03 | | | | | |
| For Truck Models: | 131-X-03 137-X-03 154-X-03 156-X-03 | | | | | | |

| STEP ONE | STEP TWO | STEP THREE | | | | | |
|---|--|--|--|--|-------------------|--|--|
| <p>Choose Vehicle OEM</p>  <p>FUSE CONNECTION</p> | <p>Choose Truck Size & Corresponding Saddle</p> <p>FULL SIZE Saddle</p>  <table border="1" data-bbox="406 1449 779 1575"> <tr> <td>For Truck Models:</td> <td>116-X-03 120-X-03 123-X-03 127-X-03</td> <td>117-X-03 121-X-03 126-X-03 128-X-03</td> </tr> </table> <p>COMPACT Saddle</p>  <table border="1" data-bbox="406 1869 779 1986"> <tr> <td>For Truck Models:</td> <td>131-X-03 137-X-03 154-X-03 156-X-03</td> </tr> </table> | For Truck Models: | 116-X-03 120-X-03 123-X-03 127-X-03 | 117-X-03 121-X-03 126-X-03 128-X-03 | For Truck Models: | 131-X-03 137-X-03 154-X-03 156-X-03 | <p>PowerSync™ Accessories</p> <p>LIGHTS PS8104</p>  <p>REMOTE KEYLESS ENTRY PS8004</p>  <p>LIGHTS</p> <p>NO COMPACT SADDLE LIGHTS STARTER KITS AVAILABLE. PLEASE REFERENCE EXPANSION OPTIONS.</p> <p>REMOTE KEYLESS ENTRY PS8004</p>  |
| For Truck Models: | 116-X-03 120-X-03 123-X-03 127-X-03 | 117-X-03 121-X-03 126-X-03 128-X-03 | | | | | |
| For Truck Models: | 131-X-03 137-X-03 154-X-03 156-X-03 | | | | | | |

TRUCK BOX FIT UP ORDERING SCENARIOS

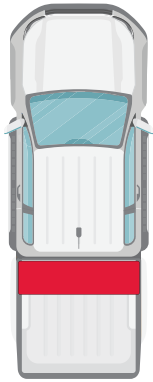

SADDLE ONLY

| | LIGHTS INSTALL | REMOTE KEYLESS INSTALL | BOTH TRUCK BOX LIGHTS & REMOTE KEYLESS ENTRY |
|-----------------------------|------------------|------------------------|--|
| Full Size Saddle | PS8103 | PS8003 | PS8103 PS8000 PS8402 |
| Full Size Saddle | PS8104 | PS8004 | PS8104 PS8000 PS8402 |
| Compact Saddle | PS8101 PS8400 | PS8000 PS8400 | PS8000 PS8101 PS8400 PS8402 |
| Compact Saddle | PS8101 PS8401 | PS8000 PS8401 | PS8000 PS8101 PS8401 PS8402 |



SADDLE & 2 LO-SIDES

| | LIGHTS INSTALL | REMOTE KEYLESS INSTALL | BOTH TRUCK BOX LIGHTS REMOTE KEYLESS ENTRY | |
|-----------------------------|--|--|--|----------------------------|
| Full Size Saddle | PS8103 PS8101 - Qty 2 PS8402 PS8403 PS8404 | PS8003 PS8002 - Qty 2 PS8402 PS8403 PS8404 | PS8103 PS8101 - Qty 2 PS8000 PS8002 - Qty 2 | PS8402 PS8403 PS8404 |
| Full Size Saddle | PS8104 PS8101 - Qty 2 PS8402 PS8403 PS8404 | PS8004 PS8002 - Qty 2 PS8402 PS8403 PS8404 | PS8104 PS8101 - Qty 2 PS8000 PS8002 - Qty 2 | PS8402 PS8403 PS8404 |
| Compact Saddle | PS8101 - Qty 3 PS8400 PS8402 PS8403 PS8404 | PS8000 PS8002 - Qty 2 PS8400 PS8402 PS8403 PS8404 | PS8101 - Qty 3 PS8000 PS8002 - Qty 2 PS8400 | PS8402 PS8403 PS8404 |
| Compact Saddle | PS8101 - Qty 3 PS8401 PS8402 PS8403 PS8404 | PS8000 PS8002 - Qty 2 PS8401 PS8402 PS8403 PS8404 | PS8101 - Qty 3 PS8000 PS8002 - Qty 2 PS8401 | PS8402 PS8403 PS8404 |

SADDLE & DRIVER SIDE (1) LO-SIDE



OR



| | LIGHTS INSTALL | REMOTE KEYLESS INSTALL | BOTH TRUCK BOX LIGHTS & REMOTE KEYLESS ENTRY | |
|-----------------------------|---|---|--|----------------------------|
| Full Size Saddle | PS8103 PS8101 PS8402 PS8403 / 8404 | PS8003 PS8002 PS8402 PS8403 / 8404 | PS8103 PS8101 PS8000 PS8403 / 8404 | PS8000 PS8002 PS8402 |
| Full Size Saddle | PS8104 PS8101 PS8402 PS8403 / 8404 | PS8004 PS8002 PS8402 PS8403 / 8404 | PS8104 PS8101 PS8000 | PS8002 PS8402 PS8403 |
| Compact Saddle | PS8101 - Qty 2 PS8400 PS8402 PS8403 / 8404 | PS8000 PS8002 PS8400 PS8402 PS8403 / 8404 | PS8101 - Qty 2 PS8000 PS8403 / 8404 | PS8002 PS8400 PS8402 |
| Compact Saddle | PS8101 - Qty 2 PS8401 PS8402 PS8403 / 8404 | PS8000 PS8002 PS8401 PS8402 PS8403 / 8404 | PS8101 - Qty 2 PS8000 PS8403 / 8404 | PS8002 PS8401 PS8402 |

DRIVER SIDE LONG (1) LO-SIDE



| | LIGHTS INSTALL | REMOTE KEYLESS INSTALL | BOTH TRUCK BOX LIGHTS & REMOTE KEYLESS ENTRY | |
|----------------------|----------------------------|----------------------------|--|------------------|
| 164 / 165 | PS8102 PS8400 PS8403 | PS8001 PS8400 PS8403 | PS8001 PS8102 PS8400 | PS8402 PS8403 |
| 164 / 165 | PS8102 PS8401 PS8403 | PS8001 PS8401 PS8403 | PS8001 PS8102 PS8401 | PS8402 PS8403 |

DRIVER SIDE LONG (2) LO-SIDE

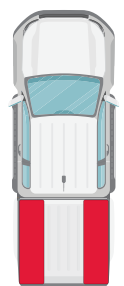

| | LIGHTS INSTALL | REMOTE KEYLESS INSTALL | BOTH TRUCK BOX LIGHTS & REMOTE KEYLESS ENTRY | |
|----------------------|--|--|--|----------------------------|
| 164 / 165 | PS8102 - Qty 2 PS8400 PS8402 PS8403 PS8404 | PS8001 - Qty 2 PS8400 PS8402 PS8403 PS8404 | PS8001 - Qty 2 PS8102 - Qty 2 PS8400 | PS8402 PS8403 PS8404 |
| 164 / 165 | PS8102 - Qty 2 PS8401 PS8402 PS8403 PS8404 | PS8001 - Qty 2 PS8401 PS8402 PS8403 PS8404 | PS8001 - Qty 2 PS8102 - Qty 2 PS8400 | PS8402 PS8403 PS8404 |

UNMATCHED PROTECTION

ALL PURPOSE CHESTS



ALL PURPOSE CHESTS KEY FEATURES

- 1** **EXTREME PROTECTION™ LOCK**
tamper-resistant retracting lock helps protect against break-ins
- 2** **90° Cover opening**
for easy access
- 3** **Heavy Duty C-Channel Reinforced Lid Construction**
for maximum durability
- 4** **Dual Stage Automotive Rotary Latch and Heavy Duty Looped Strikers**
provide extreme security
- 5** **Unique Offset Hinges**
allows chest to lie flat against truck
- 6** **Automotive D-Shaped Ribbed Rubber Weather Stripping**
keeps its shape even after years of service
- 7** **Sliding Steel Tray**
all chests except compact

LIFETIME LIMITED WARRANTY

A LOW-RIDER WORK HORSE

Maximize your visibility with All-Purpose Chests that sit below the bedrail, accommodating tonneau covers and lids. An angled body design allows the chest to fit in fifth-wheel trailer configurations. The cover opens to 90° for maximum access using a unique offset hinge design that still allows installation flush against the truck cab. For durability, they're built of steel and finished with Brite White or Gloss Black ARMOR TUF® Powder Coat, or diamond plate aluminum (Clear, Gloss Black, or Textured Black).

ALUMINUM DIAMOND PLATE



Clear ARMOR TUF® Powder Coat



Textured Matte Black ARMOR TUF® Powder Coat



Gloss Black ARMOR TUF® Powder Coat



Brite White ARMOR TUF® Powder Coat

STEEL



Brite White ARMOR TUF® Powder Coat





Gloss Black ARMOR TUF® Powder Coat

Choice Options: X = 0 (Clear) or X = 3 (Brite White) or X = 5 (Gloss Black) or X = 52 (Textured Matte Black)



COMPACT
6.0 CUBIC FEET

ALUMINUM

-  644-0-01
 -  644-5-01
- Ship Weight: 37 Lbs.

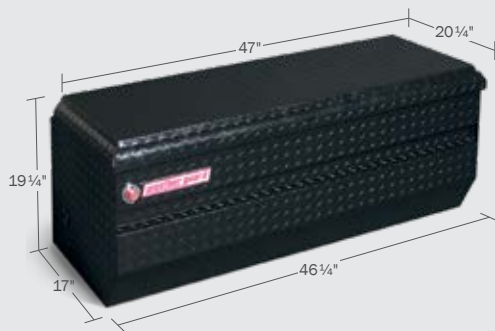

STEEL

-  645-3-01
- Ship Weight: 67 Lbs.



FULL/COMPACT
10.0 CUBIC FEET

ALUMINUM

-  674-0-01
 -  674-5-01
 -  674-52-01
- Ship Weight: 43 Lbs.

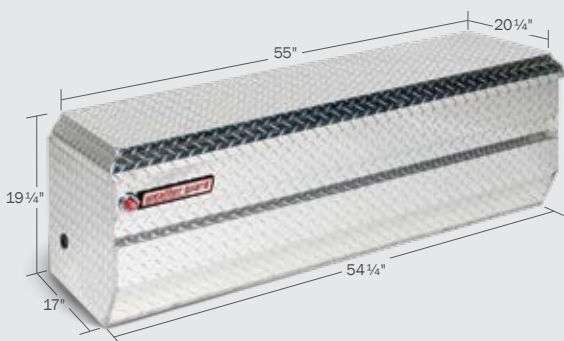

STEEL

-  675-3-01
- Ship Weight: 80 Lbs.





FULL/COMPACT
12.0 CUBIC FEET

ALUMINUM

-  654-0-01
 -  654-5-01
- Ship Weight: 52 Lbs.



STEEL

-  655-3-01
 -  655-5-01
- Ship Weight: 94 Lbs.





FULL-SIZE STANDARD
13.1 CUBIC FEET

ALUMINUM

-  664-0-01
 -  664-5-01
 -  664-52-01
- Ship Weight: 57 Lbs.

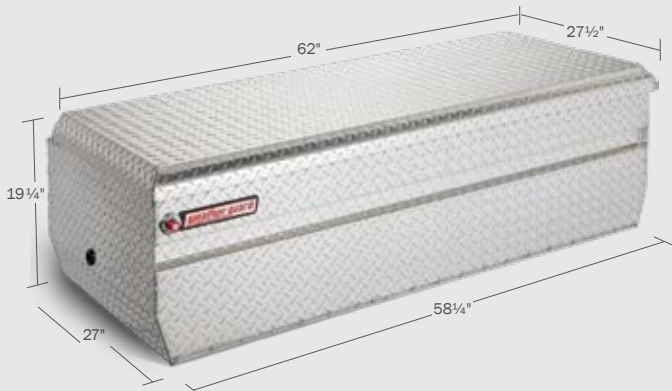

STEEL

-  665-3-01
 -  665-5-01
- Ship Weight: 112 Lbs.



FULL-SIZE EXTRA WIDE
18.6 CUBIC FEET

ALUMINUM

-  684-0-01
 -  684-5-01
- Ship Weight: 71 Lbs.

STEEL

-  685-3-01
- Ship Weight: 134 Lbs.

UNMATCHED PROTECTION WHEEL WELL BOXES



WHEEL WELL BOX KEY FEATURES

- 1** EXTREME PROTECTION[™] LOCK
tamper-resistant retracting lock helps protect against break-ins
- 2** 90° Cover opening
for easy access
- 3** Heavy Duty C-Channel Reinforced Lid Construction
for maximum durability
- 4** Automotive D-Shaped Ribbed Rubber Weather Stripping
keeps its shape even after years of service
- 5** ARMOR TUF[®]
Powder Coat Protection

LIFETIME LIMITED WARRANTY

MAKING USE OF SPACE AROUND THE WHEEL WELLS

WEATHER GUARD[®] has figured out a way to make use of otherwise unutilized truck bed space above and behind the wheel wells with these uniquely shaped boxes. They establish a great location for storing small parts and hand tools to which you often need quick, easy access. They're constructed of either steel—protected with a Brite White ARMOR TUF[®] Powder Coat finish—or aluminum diamond plate (Clear or Gloss Black). Wheel Well Boxes leave plenty of room in the truck bed for hauling around your weekend toys.

DRIVER/PASSENGER-SIDE STANDARD

2.1 CUBIC FEET

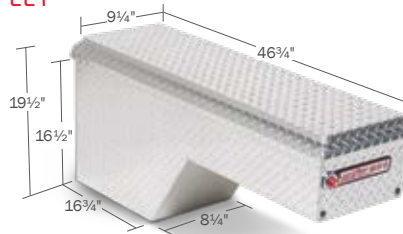

ALUMINUM

- 170-0-01 (driver)
 - 171-0-01 (passenger)
 - 170-5-01 (driver)
 - 171-5-01 (passenger)
- Ship Weight: 36 Lbs.

STEEL

- 160-3-01 (driver)
 - 161-3-01 (passenger)
- Ship Weight: 53 Lbs.

DRIVER/PASSENGER-SIDE WIDE

3.4 CUBIC FEET

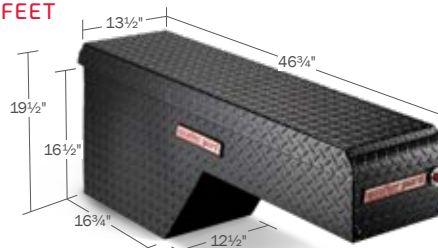

ALUMINUM

- 172-0-01 (driver)
 - 173-0-01 (passenger)
 - 172-5-01 (driver)
 - 173-5-01 (passenger)
- Ship Weight: 42 Lbs.

STEEL

- 162-3-01 (driver)
 - 163-3-01 (passenger)
- Ship Weight: 66 Lbs.

TRUCK BOX ACCESSORIES

KEEP YOUR TOOLS AND EQUIPMENT ORGANIZED AND EASY TO ACCESS

STEEL DIVIDER TRAY

617 – 26¹/₂"L x 14"W

Ship Weight: 14 Lbs.

FITS: 114-X-01, 115-X-01, 116-X-03, 117-X-03, 684-X-01, 685-X-01



STEEL DIVIDER TRAY

615 – 19¹/₄"L x 14"W

Ship Weight: 14 Lbs.

FITS: 121-X-03, 123-X-03, 124-X-01, 126-X-03, 127-X-03, 128-X-03, 131-X-03, 136-X-03, 154-X-03, 156-X-03, 654-X-01, 655-X-01, 664-X-01, 665-X-01, 674-X-01, 675-X-01



TRAYS

200-3 – 41¹/₂"L x 9¹/₂"W

Ship Weight: 17 Lbs.

202-3 – 24"L x 9¹/₂"W

Ship Weight: 12 Lbs.

16-gauge steel with adjustable dividers; bolts to back wall of cabinet.



Shown in Hi-Side Box

IN-BED STORAGE PACK RAT® DRAWER UNITS

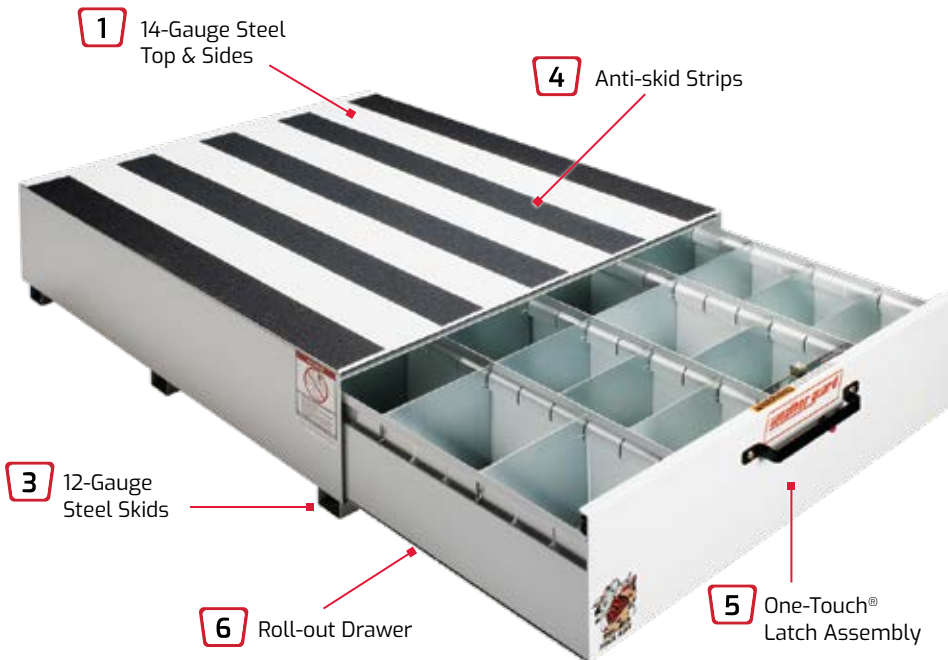

PACK RAT® DRAWER UNIT KEY FEATURES

- 1** 14-Gauge steel top and sides allows 750 Lb. load rating
- 2** Drawer load rating 425 Lbs. evenly distributed
- 3** 12-Gauge steel skids for extra strength
- 4** Anti-skid strips provide traction for work boots
- 5** One-Touch® latch assembly easy, one-hand operation
- 6** Roll-out drawer easy access and organization
- 7** Limited Lifetime Warranty unparalleled quality

LIFETIME LIMITED WARRANTY

HEAVY-DUTY STORAGE KEEPS BED SPACE OPEN AND YOU ORGANIZED

The Heavy-Duty PACK RAT® drawer units can be mounted inside the rear of the vehicle and give you easy access to large tools and supplies while leaving floor space open. These rugged units are constructed of 14-gauge steel on the top and sides, giving you a 750 pound load rating and placing them among the sturdiest items in the back of your truck.

STANDARD DRAWER UNIT 305-3

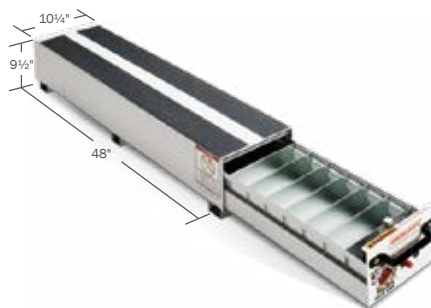

1 COMPARTMENTS, 6 DIVIDERS.

Each Drawer Compartment: 5"H x 9 3/4"W x 45"L

Ship Weight: 106 Lbs.

STANDARD DRAWER UNIT 306-3



2 COMPARTMENTS, 12 DIVIDERS.

Each Drawer Compartment: 5"H x 9 3/4"W x 45"L

Ship Weight: 179 Lbs.

IN-BED STORAGE PACK RAT® DRAWER UNITS

STANDARD DRAWER UNIT 307-3

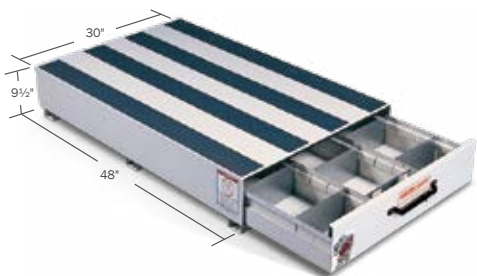

**3 COMPARTMENTS,
18 DIVIDERS.**

Each Drawer Compartment: 5"H x 9 3/4"W x 45"L

Ship Weight: 247 Lbs.

STANDARD DRAWER UNIT 308-3 (white) 308-5 (black)



**4 COMPARTMENTS,
24 DIVIDERS.**

Each Drawer Compartment: 5"H x 9 3/4"W x 45"L

Ship Weight: 322 Lbs.

STANDARD DRAWER UNIT 335-3

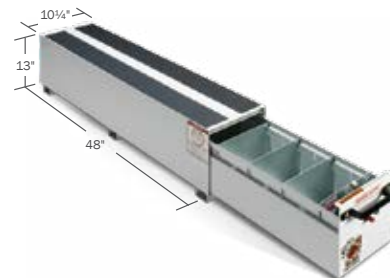

**1 COMPARTMENT,
6 DIVIDERS.**

Each Drawer Compartment: 8 1/2"H x 9 3/4"W x 45"L

Ship Weight: 130 Lbs.

STANDARD DRAWER UNIT 336-3

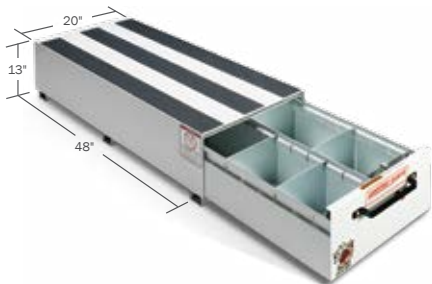

**2 COMPARTMENTS,
12 DIVIDERS.**

Each Drawer Compartment: 8 1/2"H x 9 3/4"W x 45"L

Ship Weight: 210 Lbs.

STANDARD DRAWER UNIT 337-3

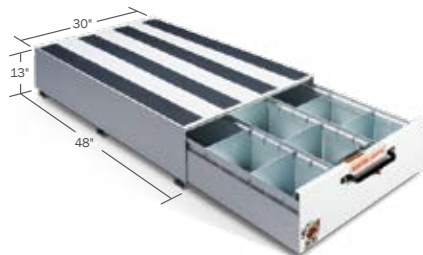

**3 COMPARTMENTS,
18 DIVIDERS.**

Each Drawer Compartment: 8 1/2"H x 9 3/4"W x 45"L

Ship Weight: 294 Lbs.

STANDARD DRAWER UNIT 338-3 (white) 338-5 (black)



**4 COMPARTMENTS,
24 DIVIDERS.**

Each Drawer Compartment: 8 1/2"H x 9 3/4"W x 45"L

Ship Weight: 383 Lbs.

IN-BED STORAGE PACK RAT® DRAWER UNITS

IN-BED STORAGE

EXTRA-WIDE COMPARTMENT 304-3

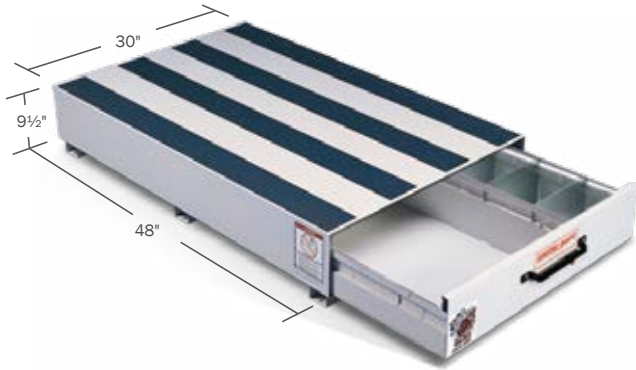

**2 COMPARTMENTS,
6 DIVIDERS.**

Small Compartment: 5"H x 9¾"W x 45"L
Large Compartment: 5"H x 19½"W x 45"L
Ship Weight: 220 Lbs.

EXTRA-WIDE COMPARTMENT 334-3

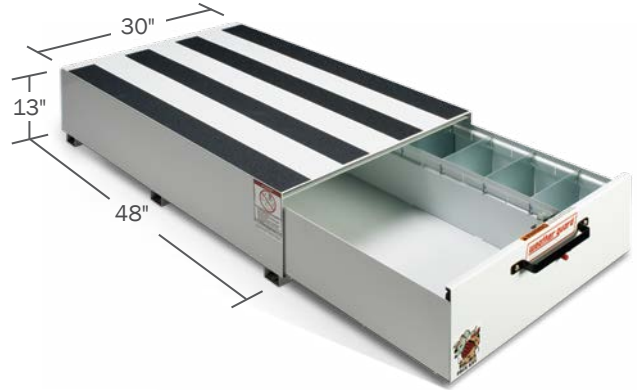

**2 COMPARTMENTS,
6 DIVIDERS.**

Small Compartment: 8½"H x 9¾"W x 45"L
Large Compartment: 5"H x 19½"W x 21"L
Ship Weight: 245 Lbs.

SHORT DRAWER UNIT 301-3

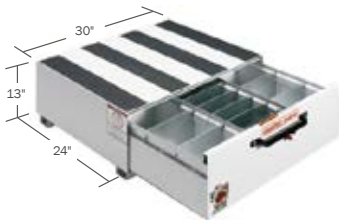

**3 COMPARTMENTS,
12 DIVIDERS.**

Each Drawer Compartment: 8½"H x 9¾"W x 21"L
Ship Weight: 169 Lbs.

SHORT DRAWER UNIT 303-3

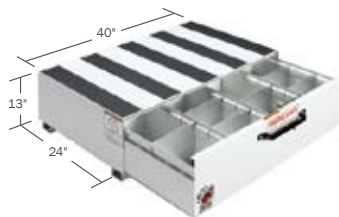

**4 COMPARTMENTS,
12 DIVIDERS.**

Each Drawer Compartment: 8½"H x 9¾"W x 21"L
Ship Weight: 217 Lbs.

STANDARD DRAWER UNIT 312-3

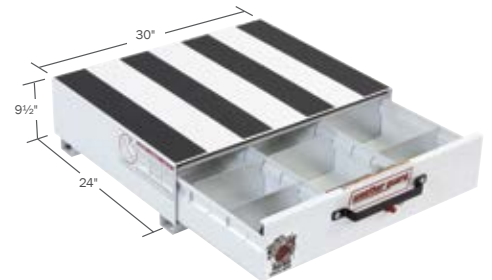

**3 COMPARTMENTS,
12 DIVIDERS.**

Each Drawer Compartment: 5"H x 9¾"W x 21"L
Ship Weight: 151 Lbs.

DRAWER DIVIDERS 300

DRAWER DIVIDERS 302

IN-BED STORAGE TRANSFER TANKS

TRANSFER TANK KEY FEATURES

- 1** Vented filler cap prevents excessive pressure build-up
- 2** Welded Interior Baffle Design reduces fuel movement
- 3** Reinforced with 12 gauge steel except 359 model does not require reinforcement for optimal performance
- 4** Isolation mounting reduces road vibration unparalleled quality
- 5** C-channel check support for trouble-free operation
- 6** Limited Lifetime Warranty for peace of mind

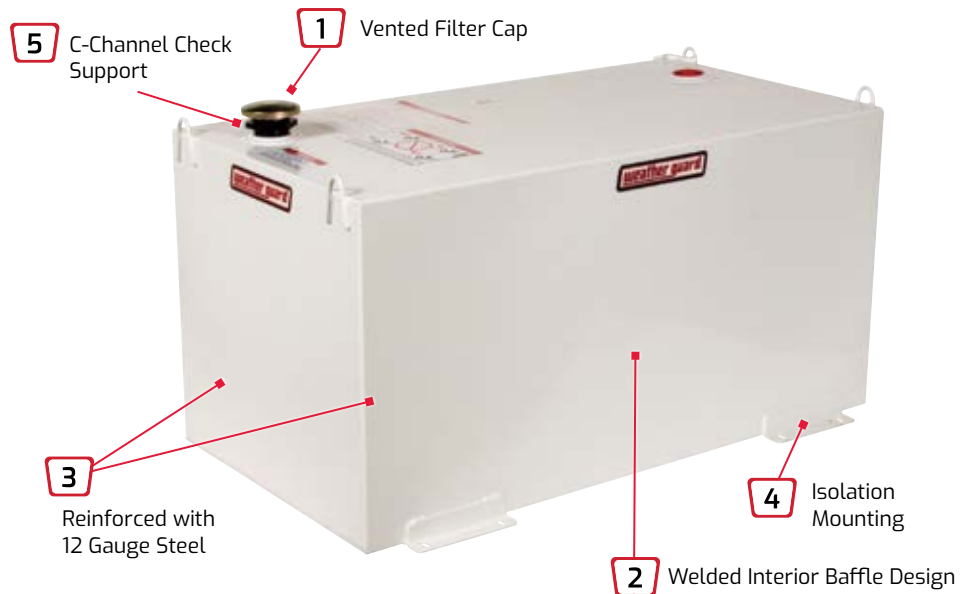

**LIFETIME LIMITED
WARRANTY**

FOR TRANSPORTING DIESEL FUEL

WEATHER GUARD® Transfer tanks offer a safer mode of transporting diesel fuel to your jobsite and beyond. L-shaped tanks are designed to be used with Gull Wing Boxes and Saddle Boxes only; rectangular tanks are designed for full-size pickup trucks. Ranging in capacity from 50-110 gallons, WEATHER GUARD® Transfer Tanks feature full arc-welded, heavy 14-gauge steel construction for long-lasting durability. The interior baffle design reduces fuel movement and provides extra tank reinforcement. The lockable vented filler cap prevents excessive pressure build-up and the threaded filler neck accepts standard 2" threaded pipe. Installation is easy using the heavy-duty lifting loops and secure plate-steel flange bed mounting points. All tanks are protected with Brite White or Gloss Black ARMOR TUF® Powder Coat Finish for years of durability, and backed by a Limited Lifetime Warranty.

STEEL TRANSFER TANK 50 GAL. CAPACITY

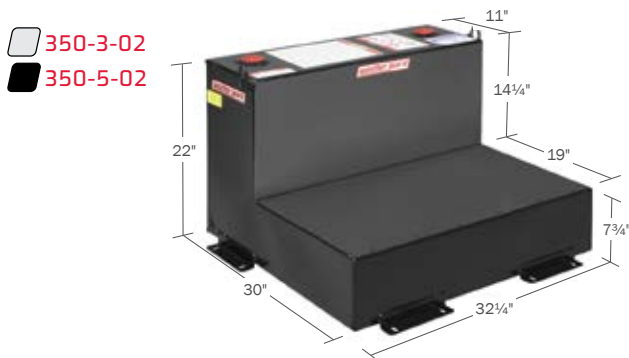

For compact pickups. May be used in combination with WEATHER GUARD® Gull Wing and Saddle Boxes.

Product Weight: 122 Lbs. Ship Weight: 132 Lbs.

STEEL TRANSFER TANK 75 GAL. CAPACITY





For full-size short-bed pickups. May be used in combination with WEATHER GUARD® Gull Wing and Saddle Boxes.

Product Weight: 168 Lbs. Ship Weight: 180 Lbs.

IN-BED STORAGE TRANSFER TANKS

IN-BED STORAGE

STEEL TRANSFER TANK 90 GAL. CAPACITY

-  354-3-02
-  354-5-02



For full-size pickups. May be used in combination with WEATHER GUARD® Gull Wing and Saddle Boxes.

Product Weight: 196 Lbs. Ship Weight: 208 Lbs.

STEEL TRANSFER TANK 100 GAL. CAPACITY

-  358-3-02
-  358-5-02



For full-size pickups.

Product Weight: 168 Lbs. Ship Weight: 178 Lbs.

STEEL TRANSFER TANK 50 GAL. CAPACITY

-  359-3-02
-  359-5-02

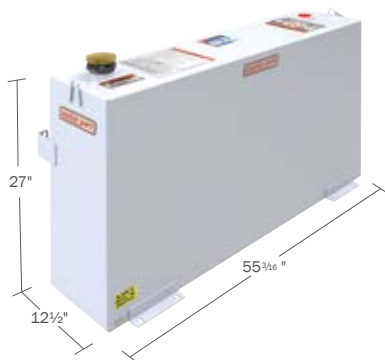

Designed for most full-size pickups.

Product Weight: 124 Lbs. Ship Weight: 136 Lbs.

STEEL TRANSFER TANK 110 GAL. CAPACITY

-  362-3-02
-  362-5-02



For full-size pickups. May be used in combination with WEATHER GUARD® Gull Wing and Saddle Boxes.

Product Weight: 220 Lbs. Ship Weight: 234 Lbs.

UNDERBED STORAGE STEEL UNDERBED BOXES

STEEL UNDERBED BOX KEY FEATURES

- 1** Gutter design & weather stripping easy and positive door closure that protects against the elements
- 2** 3-point latching system for optimum security and weather resistance
- 3** Stainless Steel D Handle for easy and positive door closure, and added protection against break-ins
- 4** Tool-less quick release drop down door full and easy access, adjusts from 90° to 180°
- 5** Automotive D-Shaped Ribbed Rubber Weather Stripping keeps its shape even after years of service
- 6** ARMOR TUF® Powder Coat Protection
- 7** ALUMINUM DOOR and hinge

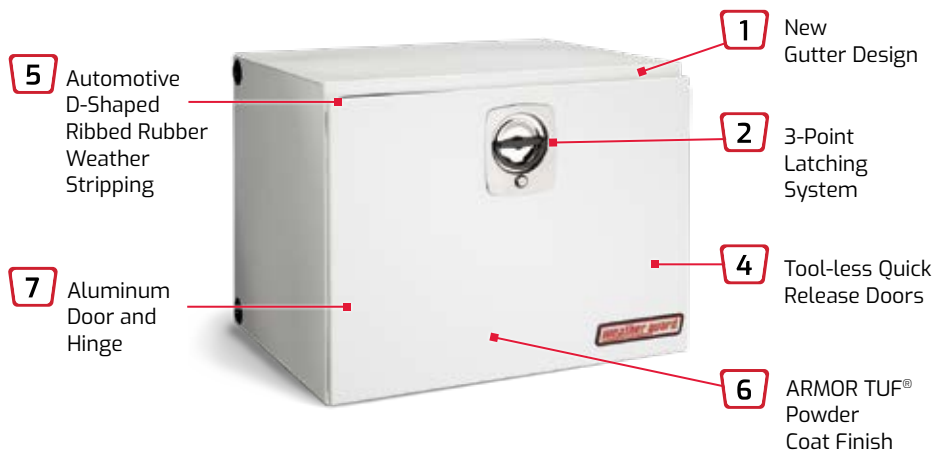

WIDE SELECTION OF SIZES FOR YOUR NEEDS

WEATHER GUARD® Steel Underbed Boxes come in three size groupings: compact, standard and jumbo. A Brite White or Gloss Black ARMOR TUF® Powder Coat enhances the durability of these boxes' heavy-gauge steel. Steel Underbed Boxes are supplied with an aluminum door and hinge for superior resistance to rust and corrosion.

LIFETIME LIMITED WARRANTY

COMPACT UNDERBED



2.3 CUBIC FEET

- 525-3-02
- 525-5-02

Ship Weight: 45 Lbs.

Door Opening Measures:
10 1/2"H x 22 1/2"W

STANDARD UNDERBED



4.5 CUBIC FEET

- 524-3-02
- 524-5-02

Ship Weight: 45 Lbs.
(24 1/8"L x 18 1/4"W x 18 1/8"H)

Door Opening Measures:
14 1/2"H x 22 1/2"W

5.6 CUBIC FEET

- 530-3-02
- 530-5-02

Ship Weight: 70 Lbs.
(30 1/8"L x 18 1/4"W x 18 1/8"H)

Door Opening Measures:
14 1/2"H x 28 1/2"W

6.7 CUBIC FEET

- 536-3-02
- 536-5-02 (Shown)

Ship Weight: 82 Lbs.

Door Opening Measures:
14 1/2"H x 34 1/4"W

9.1 CUBIC FEET

- 548-3-02
- 548-5-02

Ship Weight: 100 Lbs.
(48 1/8"L x 18 1/4"W x 18 1/8"H)

Door Opening Measures:
14 1/2"H x 46 1/4"W

11.2 CUBIC FEET

- 560-3-02
- 560-5-02

Ship Weight: 135 Lbs.
(60 1/8"L x 18 1/4"W x 18 1/8"H)

Door Opening Measures:
14 1/2"H x 58 1/4"W

JUMBO UNDERBED



12.1 CUBIC FEET

- 538-3-02 (Shown)
- 538-5-02

Ship Weight: 111 Lbs.
(36 1/8"L x 24 1/4"W x 24 1/8"H)

Door Opening Measures:
20 1/2"H x 34 1/4"W

16.2 CUBIC FEET

- 550-3-02
- 550-5-02

Ship Weight: 145 Lbs.
(48 1/8"L x 24 1/4"W x 24 1/8"H)

Door Opening Measures:
20 1/2"H x 46 1/4"W

20.2 CUBIC FEET

- 562-5-02

Ship Weight: 181 Lbs.
(60 1/8"L x 24 1/4"W x 24 1/8"H)

Door Opening Measures:
20 1/2"H x 58 1/4"W

UNDERBED STORAGE ALUMINUM UNDERBED BOXES

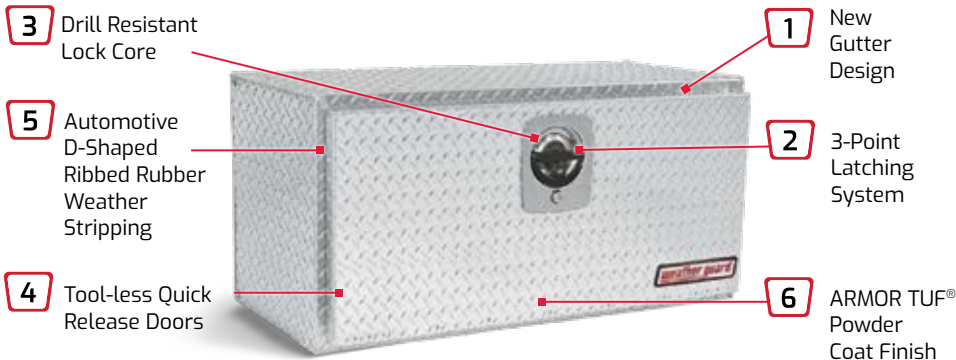

DURABILITY AT LIGHTER WEIGHT

WEATHER GUARD® Aluminum Underbed Boxes are available in compact, standard and jumbo versions to meet your specific needs. Clear or Gloss Black ARMOR TUF® Powder Coat finishes extend the ruggedness of the diamond plate aluminum.



TOOL-LESS QUICK RELEASE DROP DOWN DOOR



WEATHER STRIPPING protects contents from the weather.



STAINLESS STEEL D HANDLE With Drill-resistant Lock Core

ALUMINUM UNDERBED BOX KEY FEATURES

- 1** Gutter design & weather stripping *easy and positive door closure that protects against the elements*
- 2** 3-point latching system *for optimum security and weather resistance*
- 3** Stainless Steel D Handle *for easy and positive door closure, and added protection against break-ins*
- 4** Tool-less quick release drop down door *full and easy access, adjusts from 90° to 180°*
- 5** Automotive D-Shaped Ribbed Rubber Weather Stripping *keeps its shape even after years of service*
- 6** ARMOR TUF® Powder Coat Protection

LIFETIME LIMITED WARRANTY

COMPACT UNDERBED



2.4 CUBIC FEET

622-0-02

622-5-02

Ship Weight: 24 Lbs.

Door Opening Measures:
9 1/4"H x 19 1/4"W

STANDARD UNDERBED

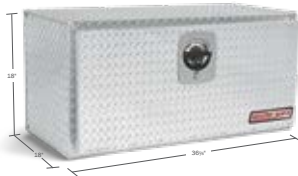

4.3 CUBIC FEET

627-0-02

Ship Weight: 35 Lbs.
(24 1/8"L x 18 1/4"W x 18"H)

Door Opening Measures:
13 1/2"H x 19 1/4"W

5.4 CUBIC FEET

631-0-02

631-5-02

Ship Weight: 42 Lbs.
(30 1/2"L x 18"W x 18"H)

Door Opening Measures:
13 1/2"H x 25 1/4"W

6.5 CUBIC FEET

636-0-02 (Shown)

636-5-02

Ship Weight: 47 Lbs.
(36 1/2"L x 18"W x 18"H)

Door Opening Measures:
13 1/2"H x 34 1/4"W

8.6 CUBIC FEET

648-0-02

Ship Weight: 62 Lbs.
(48 1/2"L x 18"W x 18"H)

Door Opening Measures:
13 1/2"H x 43 1/4"W

11.2 CUBIC FEET

660-0-02

660-5-02

Ship Weight: 135 Lbs.
(60 1/2"L x 18"W x 18"H)

Door Opening Measures:
13 1/2"H x 55 1/4"W

JUMBO UNDERBED



12.2 CUBIC FEET

638-0-02

Ship Weight: 65 Lbs.
(36 1/2"L x 24"W x 24"H)

Door Opening Measures:
19 1/2"H x 31 3/4"W

16 CUBIC FEET

650-0-02

Ship Weight: 81 Lbs.
(48 1/2"L x 24"W x 24"H)

Door Opening Measures:
19 1/2"H x 43 1/4"W

20 CUBIC FEET

662-0-02 (Shown)

Ship Weight: 100 Lbs.
(60 1/2"L x 24"W x 24"H)

Door Opening Measures:
19 1/2"H x 55 1/4"W

BED-RAIL MOUNT SOLUTIONS

STEEL TRUCK RACK



STEEL TRUCK RACK KEY FEATURES

- 1 No-Drill Installation** *Installs in less than an hour (15-20 minutes to assemble/30 minutes to install)*
- 2 Welded Airfoil Included** *No need to purchase an accessory, helps deflect wind*
- 3 Maximum Tie Down Points** *4 areas allow for additional tie down points on rack legs for items on rack*

LIFETIME LIMITED WARRANTY

- 3 Models - Compact Standard, Full Size Standard, Full Size Heavy Duty
- 1,000 lb. weight rated (evenly distributed) for standard racks. 1,700 lb. weight rated (evenly distributed) for heavy duty rack
- Compatible with Weather Guard boxes



NO-DRILL INSTALL



WELDED AIRFOIL INCLUDED



MAXIMUM TIE DOWN POINTS



BED-RAIL MOUNT SOLUTIONS

STEEL TRUCK RACK

FULL SIZE STEEL TRUCK RACK

1275-52-02

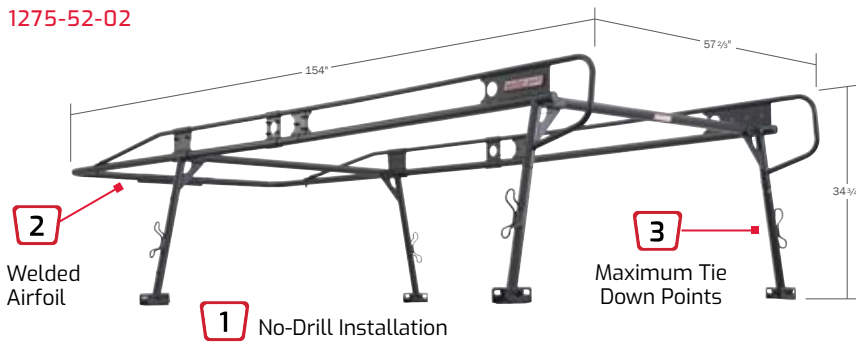

Welded Airfoil

No-Drill Installation

Maximum Tie Down Points

COMPACT STEEL TRUCK RACK

1345-52-02

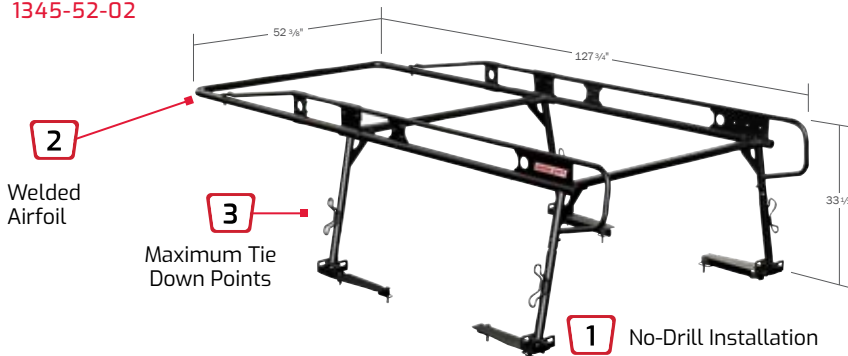

Welded Airfoil

Maximum Tie Down Points

No-Drill Installation

FULL SIZE HEAVY DUTY STEEL TRUCK RACK

1175-52-02

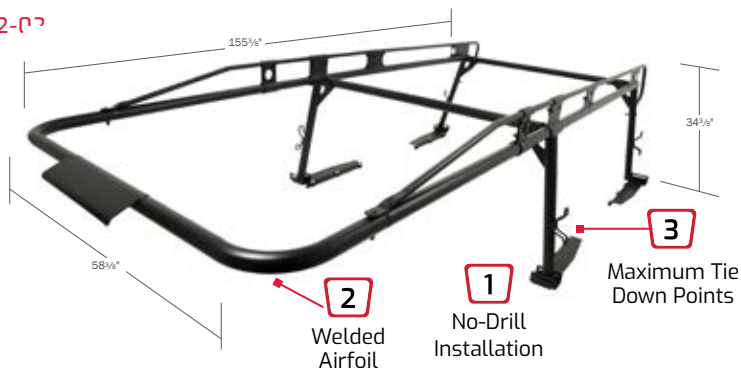

Welded Airfoil

No-Drill Installation

Maximum Tie Down Points

ACCESSORIES

FULL-SIZE CAB PROTECTOR

1059-52-01

Mounting points line up with pre-drilled holes on Full Size Steel Truck Rack Front legs

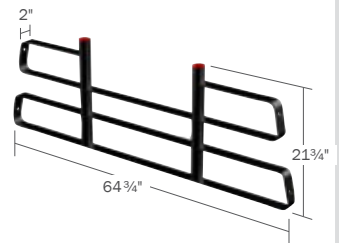

Matte Black Finish
Matches Compact Steel Truck Rack

Ship Weight: 61 Lbs.

COMPACT CAB PROTECTOR

1058-52-01

Mounting points line up with pre-drilled holes on Compact Steel Truck Rack Front legs

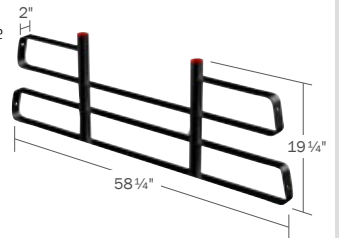

Matte Black Finish
Matches Compact Steel Truck Rack

Ship Weight: 61 Lbs.

FULL-SIZE ACCESSORY CROSS MEMBER

1290-52-01

No-Drill Installation utilizes locking pins (same as rear cross member on rack)

Matte Black Finish
Matches Compact Steel Truck Rack



Ship Weight: 15.5 Lbs.

COMPACT ACCESSORY CROSS MEMBER

1390-52-01

No-Drill Installation utilizes locking pins (same as rear cross member on rack)

Matte Black Finish
Matches Compact Steel Truck Rack

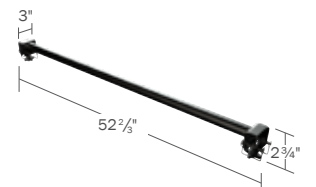

Ship Weight: 9.1 Lbs.

RATCHET STRAPS

1057-52-01

Works with the 1175-52-02, 1275-52-02 & 1345-52-02.



Installation requires product to be drilled into truck rack and is permanently installed to the rack.

Quick release button retracts the straps automatically for easy slowing when not in use.

Straps rated to 1,000 Lbs.

INCLUDES:

Set of 2 ratchet straps, mounting bracket, and mounting hardware

REAR ROLLING CROSS MEMBER

1090-52-01

1091-52-01

1092-52-01

Easily roll ladders and other long items onto the truck rack.

Matte black Finish
No-Drill Installation

Ship Weight: 10.5 lbs.



HEAVY DUTY CROSS MEMBER

1190-52-01

No-Drill Installation utilizes locking pins (same as rear cross member on rack)

Matte Black Finish
Matches Full Size Heavy Duty Steel Truck Rack

Ship Weight: 12.9 Lbs.



BED-RAIL MOUNT SOLUTIONS

STEEL SERVICE BODY RACK

KEY FEATURES

- 1 WEATHER GUARD® Truck Equipment offers the same quality and durability on our Steel Service Body Rack as on our other field-proven racks.

NOTE: Do not mount on aluminum, plastic, fiberglass or top-opening service body trucks. Mount only on steel service bodies.

STEEL SERVICE BODY RACK

LOAD CAPACITY 1000 LBS.

1225

For full-size steel service bodies.

INCLUDES: legs, side rails and cross members.

Ship Weight: 233 Lbs.

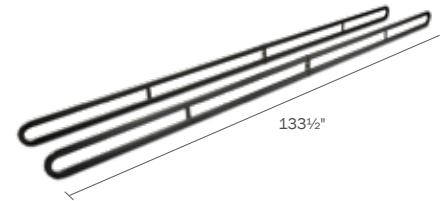

LIFETIME LIMITED WARRANTY

ALUMINUM SERVICE BODY RACK

KEY FEATURES

- 1 The WEATHER GUARD® Aluminum Service Body Rack is designed to make loading or unloading a ladder a "one-person" job.
- 2 Front post adjusts in height and swivels to allow for easy positioning of ladder during removal or placement
- 3 Both posts have a wide mounting

NOTE: Do not mount on an aluminum plastic or fiberglass service body. Mount on steel service body only.

ALUMINUM SERVICE BODY RACK

LOAD CAPACITY 200 LBS.

1425-3

For full-size and compact service body trucks on both driver and passenger sides.

Front post adjusts 21³/₁₆"-35³/₁₆"

Rear post is stationary at 21³/₁₆" (shown left)

Front post adjusts 16"-30"

Rear post is stationary at 16¹/₄" (shown right)

Ship Weight: 22 Lbs.

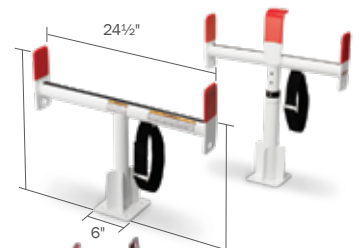

BED-RAIL MOUNT SOLUTIONS WEEKENDER® TRUCK RACK



KEY FEATURES

- 1 Easy on, easy off for that occasional need to carry a ladder or long material.
- 2 Uprights should be removed when not in use.
- 3 Adjustable, tubular steel pockets bolt into the side of the truck bed.
- 4 A set-screw holds the upright in place.
- 5 Load bar is adjustable to accommodate the varied widths of ladders.
- 6 Constructed of 1½" x 1½", 14-gauge wall steel tubing.
- 7 Joints are fully arc-welded.
- 8 Mounting bracket allows WEEKENDER® Truck Rack to be installed on driver side or curb side of truck.

If installing to an aluminum bed, please purchase the 70322 Aluminum Upfit Kit.

LIFETIME LIMITED WARRANTY

HORIZONTAL LOAD CAPACITY 250 LBS.

1450
For '95 and newer pickups, Chevy, Dodge, Ford and Toyota Tundra.

Ship Weight: 56 Lbs.



PROTECT-A-RAIL® CAB PROTECTORS/ACCESSORIES

FOR COMPACT PICKUPS

1909-5-01 (black)

Punched steel screen cab protector.
(Requires separate purchase of Installation Kit.)

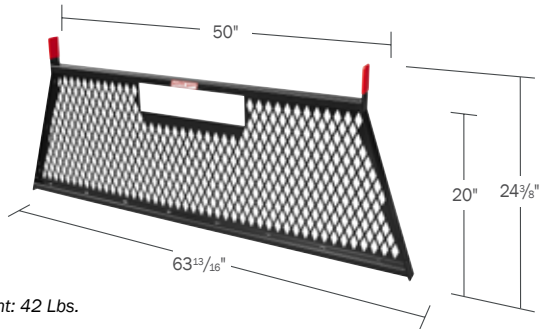

Ship Weight: 42 Lbs.

FOR FULL-SIZE PICKUPS

1905-0-02

Aluminum frame cab protector. Features a lightweight extruded aluminum frame with 14-gauge steel louvers.
(Requires separate purchase of Installation Kit.)

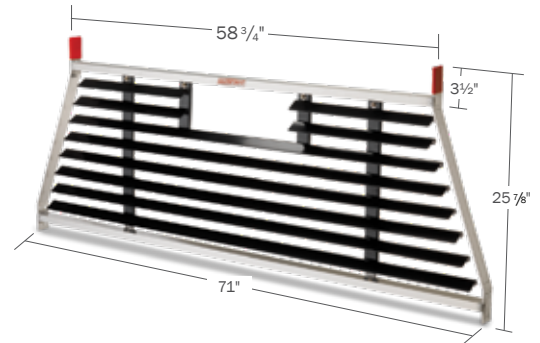

Ship Weight: 33 Lbs.

FOR FULL-SIZE PICKUPS

1904-3-02 (white)

1904-5-02 (black)

Steel louvered cab protector. Features a steel frame and 14-gauge steel louvers. (Requires separate purchase of Installation Kit.)

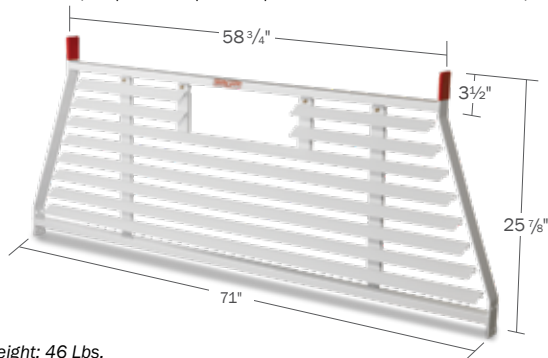

Ship Weight: 46 Lbs.

FOR FULL-SIZE PICKUPS

1906-3-02 (white)

1906-5-02 (black)

Punched steel screen cab protector.
(Requires separate purchase of Installation Kit.)

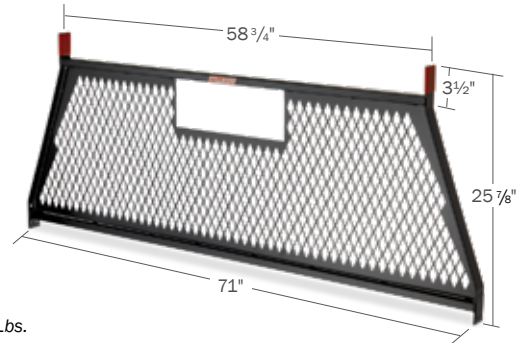

Ship Weight: 33 Lbs.

FOR FULL-SIZE PICKUPS

1908

Heavy-duty cab protector.
(Requires separate purchase of Installation Kit.)

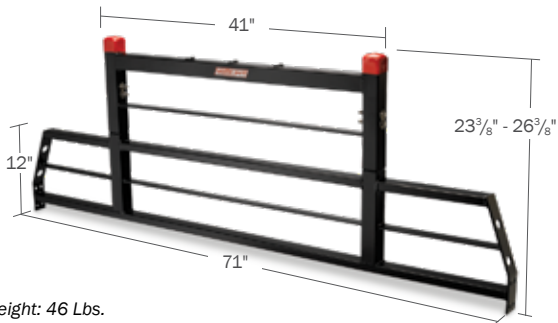

Ship Weight: 46 Lbs.

ACCESSORIES

ACCESSORIES FOR MOUNTING WARNING LIGHTS & LADDERS FOR 1908

1920

9 1/2" x 17" rectangular base.

Ship Weight: 6 Lbs.

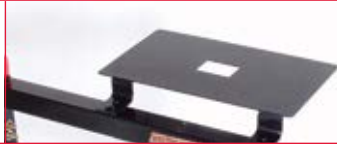

1919

7 1/2" side mount round base.

Ship Weight: 3 Lbs.



INSTALLATION KITS FOR FULL SIZE TRUCKS

| MODEL | INNER BED WIDTH DIMENSIONS | COLOR |
|-----------|----------------------------|-------|
| 1912-3-02 | 61.5" - 62.0" | White |
| 1912-5-02 | 61.5" - 62.0" | Black |
| 1913-3-02 | 62.0" - 62.5" | White |
| 1913-5-02 | 62.0" - 62.5" | Black |
| 1915-3-02 | 62.5" - 63.0" | White |
| 1915-5-02 | 62.5" - 63.0" | Black |
| 1916-3-02 | 63" - 63.5" | White |
| 1916-5-02 | 63" - 63.5" | Black |
| 1921-3-02 | 63.5" - 64.0" | White |
| 1921-5-02 | 63.5" - 64" | Black |
| 1925-3-02 | 65" - 65.5" | White |
| 1925-5-02 | 65" - 65.5" | Black |



INSTALLATION KITS FOR COMPACT TRUCKS

| MODEL | FITMENT | COLOR |
|-----------|----------------|-------|
| 1927-5-01 | Chevy Colorado | Black |
| | GMC Canyon | Black |

ALUMINUM CONDUIT CARRIER

Keep your conduit safe, secure and clean with our lightweight and durable Conduit Carrier.

237

Conduit Carrier

Ship Weight: 40 Lbs.

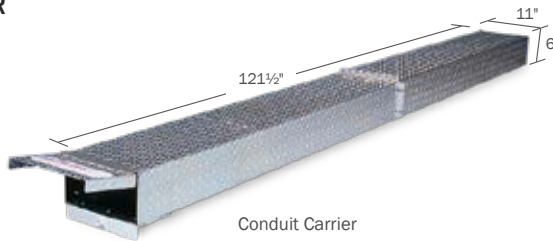

Conduit Carrier

238

6" Extension

Ship Weight: 4 Lbs.



6" Extension

MAKE-YOUR-OWN CONDUIT CARRIER

239

PVC not included. Separately purchase a section of standard 6" PVC (9ASTM D2665) plastic drain pipe.

Coordinate the length of the PVC with the length of conduit you'll be carrying.

Ship Weight: 4 Lbs.



BED-RAIL MOUNT SOLUTIONS

TRUCK RACK FIT GUIDE

| BRAND | MODEL | BED LENGTH | TRUCK RACKS | | | |
|-----------|---------------------|------------|---------------------------------|---|---|---|
| | | | 1450 | 1175-52-02 | 1275-52-02 | 1345-52-02 |
| | | | WEEKENDER HORIZONTAL RACK | HEAVY DUTY FULL SIZE STEEL TRUCK RACK - 1,700 LB. WEIGHT CAPACITY | FULL SIZE STEEL TRUCK RACK - 1,000 LB. WEIGHT CAPACITY | COMPACT STEEL TRUCK RACK - 1,000 LB. WEIGHT CAPACITY |
| CHEVROLET | COLORADO | 5' | | | | • |
| CHEVROLET | COLORADO | 6' | • | | | • |
| CHEVROLET | SILVERADO 1500 | 5-1/2' | • + 70021 | | • | |
| CHEVROLET | SILVERADO 1500 | 6' | • + 70021 | | • | |
| CHEVROLET | SILVERADO 1500 | 8' | • + 70021 | | • | |
| CHEVROLET | SILVERADO 2500/3500 | 6' | • + 70021 | • | • | |
| CHEVROLET | SILVERADO 2500/3500 | 8' | • + 70021 | • | • | |
| DODGE RAM | 1500 | 5-1/2' | • | | • | |
| DODGE RAM | 1500 | 6' | • | | • | |
| DODGE RAM | 1500 | 8' | • | | • | |
| DODGE RAM | 2500/3500 | 6' | • | • | • | |
| DODGE RAM | 2500/3500 | 8' | • | • | • | |
| FORD | RANGER | 5' | • | | | • |
| FORD | RANGER | 6' | • | | | • |
| FORD | F-150 | 5-1/2' | • | | • | |
| FORD | F-150 | 6' | • | | • | |
| FORD | F-150 | 8' | • | | • | |
| FORD | SUPER DUTY | 6-1/2' | • | • | • | |
| FORD | SUPER DUTY | 8' | • | • | • | |
| GMC | CANYON | 5' | • | | | • |
| GMC | CANYON | 6' | • | | | • |
| GMC | SIERRA 1500 | 5-1/2' | • + 70021 | | • | |
| GMC | SIERRA 1500 | 6' | • + 70021 | | • | |
| GMC | SIERRA 1500 | 8' | • + 70021 | | • | |
| GMC | SIERRA 2500/3500 | 6' | • + 70021 | • | • | |
| GMC | SIERRA 2500/3500 | 8' | • + 70021 | • | • | |
| NISSAN | FRONTIER | 4-1/2' | | | | • |
| NISSAN | FRONTIER | 6' | | | | • |
| NISSAN | TITAN | 5-1/2' | | | • | |
| NISSAN | TITAN | 6-1/2' | | | • | |
| TOYOTA | TACOMA | 5' | | | | |
| TOYOTA | TACOMA | 6' | | | | |
| TOYOTA | TUNDRA | 6' | • | | • | |
| TOYOTA | TUNDRA | 8' | • | | • | |

CONFIGURATIONS GUIDE



TRUCK BOX UPFIT

LO-SIDE BOXES (2)

184-6-03 (page 8)

SADDLE BOX

127-6-03 (page 6)



STEEL TRUCK RACK UPFIT

STEEL TRUCK RACK

1275-52-02 (page 27)

CAB PROTECTOR

1059-52-01 (page 31)



POWERSYNC™ UPFIT

SADDLE BOX

127-6-03 (page 6)

LO-SIDE BOXES

184-6-03 (page 8)

POWERSYNC™

PS8100 (page 14)



SECURE EVERY CHALLENGE

INDUSTRY-LEADING SECURITY

UNMATCHED DURABILITY & RELIABILITY

MAXIMUM ORGANIZATION & PRODUCTIVITY



LIMITED LIFETIME WARRANTY

WERNER CO. (the Manufacturer) warrants to the original purchaser, only, that WEATHER GUARD® truck products (the "WEATHER GUARD Product") will be free from defects in material and workmanship from the date of purchase and continuing for the expected lifetime of the WEATHER GUARD Product. This warranty applies to all WEATHER GUARD product except E-LINE® and Defender Series. Please call our customer service department toll free at 1.800.456.7865 with any questions or comments.

DO NOT use these products for storing or transporting flammables, explosives, hazardous materials or waste, such as gasoline, solvents, gun powder, dynamite, gases or any tanks, torches or gas powered equipment. These products are intended and safe for storing and transporting small tools and other non-combustible, non-flammable materials. Any modification made to, or unintended use of, these products may create a dangerous condition causing death, serious bodily injury or property damage.

NOTICE

Any modification or unintended use of these products shall immediately void all manufacturers warranties. Manufacturer disclaims all liability for injuries to persons or property resulting from any modification to, or unintended use of these products.

For U.S. Terms and Conditions of Sale please reference form number 78-1117. For Canada Terms and Conditions of Sale please reference form number 78-1145.

FOR MORE INFORMATION:

US - visit WEATHERGUARD.COM or call 800.456.7865

CANADA - visit WEATHERGUARD.CA or call 888.562.2251

