

VAN STORAGE SOLUTIONS

# weather guard®

SECURE EVERY CHALLENGE™



Mercedes-Benz



RAM



WEATHERGUARD.COM



# DESIGNED WITH THE PROFESSIONAL

Your future is bright when you choose WEATHER GUARD® van solutions. Our signature white increases visibility and represents quality inside and out. Since 1968 WEATHER GUARD® has formed a reputation for manufacturing the best van equipment available. Our innovations come directly from the field and provide efficient organization that maximizes space for every industry. WEATHER GUARD® doesn't just build shelves, we engineer tools of the trade that provide unmatched peace of mind.



**STRENGTH & QUALITY**



**EFFICIENT ORGANIZATION**



**TRUSTED REPUTATION**

## RACKS

- Options for all needs - drop down, quick clamp, all-purpose and safari
- EZGlide2™ Drop-Down ladder rack makes it safe and easy to load and unload ladders
- Conduit carrier accessories create space to haul long materials on top of ladder rack
- Optional ratchet strap accessories simplify the tie down process

## SHELVING & ACCESSORIES

- 18 gauge steel provides strength and durability
- Full hemmed shelves provide strength and stability with no additional structural support
- Two depths and five different length shelves maximize storage space in any van
- Full array of accessories to build customizable solutions
- Secure storage for valuables, small parts, tanks, tools and more

## BULKHEADS

- Steel and Composite options for all available OEM vans
- Clear window or metal screen options provide a clear line of sight to rear of van and side door windows
- Optional hinged door kit creates swing door access to cargo area
- Dog Hatch Door provides additional options for long material storage

## FLOOR STORAGE

- Pull-out storage units can be stacked as needed for additional storage
- Roller mounted drawers glide open to full extension
- Adjustable drawer dividers offer greater flexibility



## TABLE OF CONTENTS

<b>VEHICLE FITTING GUIDE .....</b>	<b>4</b>
Van Configurator & Pro Packages .....	4
Basic Van Configurations .....	7
<b>BULKHEADS .....</b>	<b>8</b>
Composite Van Bulkheads .....	8
Steel Van Bulkheads .....	9
Bulkhead Accessories .....	11
<b>SHELVING .....</b>	<b>12</b>
Adjustable Shelving .....	12
Mounting Kits and Shelf Components .....	13
Shelving Accessories .....	14
RedZone Accessories .....	15
EZ Cube Welded Shelving .....	16
PowerSync™ Van Shelf Lighting .....	17
<b>SPECIALTY STORAGE .....</b>	<b>18</b>
Secure Storage .....	18
Cabinets .....	19
Small Parts Storage .....	20
Floor Storage Drawer Units (Pack Rat® & Itemizers®) .....	21
Tank Holders and Door Storage .....	24
Cab Command Center .....	25
<b>ROOF RACKS .....</b>	<b>26</b>
EZGLIDE2™ Drop-Down Ladder Rack .....	26
Quick Clamp Aluminum Racks .....	28
All-Purpose Racks (Steel & Aluminum) .....	30
Safari Rack .....	32
Sliding Ladder Rack (Internal) .....	32
Conduit Carriers .....	32
Roof Rack Fitting Guide .....	33
<b>ACCESSORIES .....</b>	<b>34</b>
Work Top .....	34
Window Screens .....	34
Floor Mats .....	34
<b>PART NUMBER REFERENCE GUIDE .....</b>	<b>34-35</b>

# VEHICLE FITTING GUIDE

The Weather Guard Van catalog is organized to help you work through the five zones of your van when planning your Weather Guard storage system. The van layout figures on the next few pages provide details to get started working on your van's interior. Weather Guard PRO PACKAGES for each van roof height and wheel base combination can be used either as a complete upfit package or a starting point for a custom upfit. Weather Guard van products can be ordered as a package or item by item. The PRO PACKAGES are located on our web site at [www.weatherguard.com](http://www.weatherguard.com) and in each of our Van OEM Brochures. If you need more help, your local Weather Guard distributor is a great resource for all your upfitting questions. Go to [www.weatherguard.com](http://www.weatherguard.com) to locate a distributor near you.

## ZONE 1 BULKHEAD

- Choose bulkhead style for your van.
- Do you need windows, vented screens or solid panels?
- Do you need a hinged door?
- What tools and equipment do you hang on your bulkhead?

## ZONE 2 DRIVER SIDE

## ZONE 3 PASSENGER SIDE

- Use Vehicle Fitting Guides to determine available space in van or start with a Professional Trade Package. Find the OEM Van Brochure for your model van at [www.weatherguard.com](http://www.weatherguard.com).
- Choose shelving units that fit your daily work needs.
- What cabinets, bins and organization accessories would help you be more productive?
- Do you need to keep a space open along the side of the van for special tools or equipment?

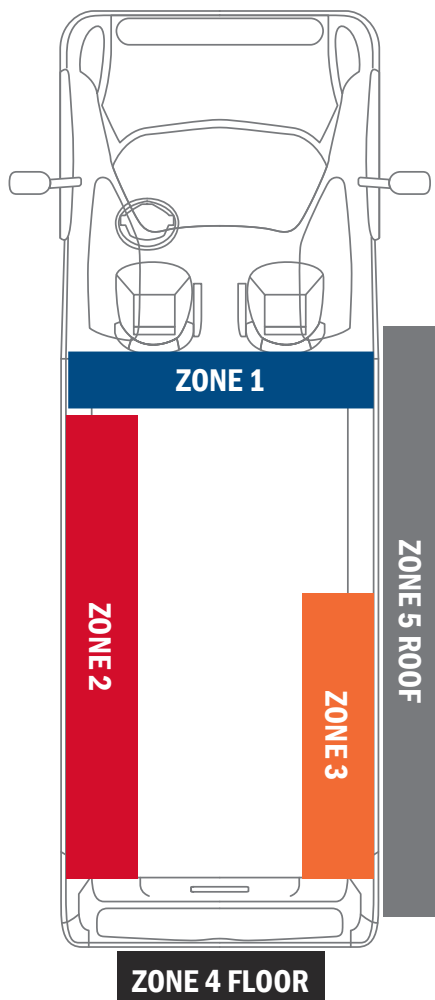

## ZONE 4 FLOOR

- PACK RAT® Drawer Units and ITEMIZER® Drawer Units mount to the floor of the van and provide easy access to tools, parts, and equipment.
- What space do you need to keep open between the shelving for equipment you store in your van or transport to your jobsite?

## ZONE 5 ROOF

- What do you carry on your roof and how often do you need to reach it?
- How tall is your van roof? Low, Mid, or High?
- Check your van manufacturer's web site for how much weight it can safely carry.
- Choose from EZGlide2™ Drop-Down, QUICK CLAMP® or All-Purpose Racks for your best roof storage solution.
- Consider roof rack accessories like conduit carriers and tie downs.

## VAN CONFIGURATOR



**CUSTOM CONFIGURATOR**  
Van Edition



### READY. SET. CUSTOMIZE.

Use our web-based tool to create a custom storage solution & to find an upfitter for your van.

Visit us online at  
[WEATHERGUARD.COM/VAN-CONFIGURATOR](http://WEATHERGUARD.COM/VAN-CONFIGURATOR)

## PRO PACKAGES

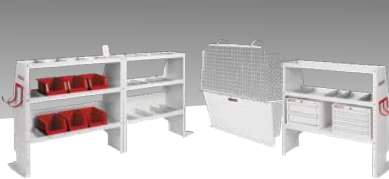

### A SIMPLIFIED START.

Select a pre-configured pro package to help you start your van storage solution.

SCAN QR CODE or visit us online at  
[WEATHERGUARD.COM](http://WEATHERGUARD.COM) (Select Van Solutions, and then Packages tab)

# VAN INTERIOR DIMENSIONS FITTING GUIDE

## IMPORTANT UPFIT TIPS

- Always measure your van carefully to make sure that the equipment you choose will fit properly.
- Verify the location of the gas tank, brake lines, wiring harness, etc. before installing any equipment.
- Shelving Mounting Kits are recommended.
- Do not exceed the van manufacturer's roof load rating.

### FORD TRANSIT

The dimensions show in this guide refer to model year 2021 and earlier Ford Transit vans.

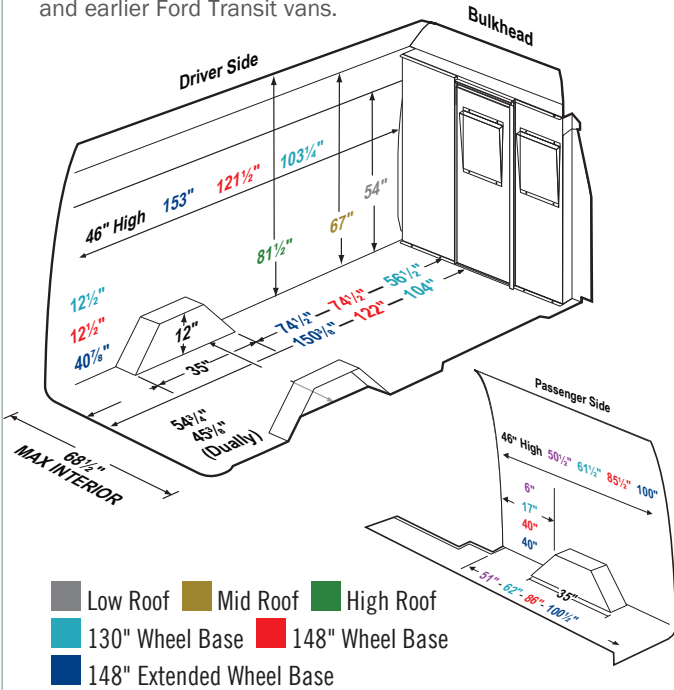

### FORD TRANSIT CONNECT

The dimensions show in this guide refer to model year 2014-2021 Ford Transit Connect vans.

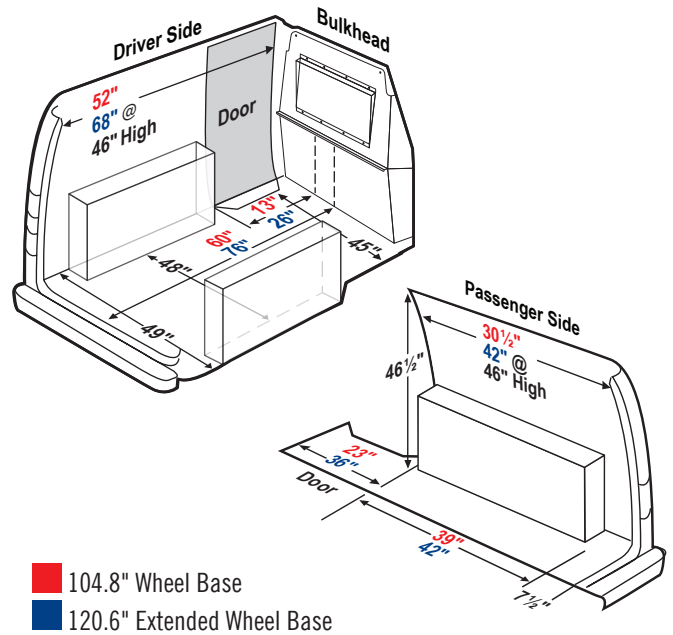

### CHEVROLET EXPRESS / GMC SAVANA

The dimensions show in this guide refer to model year 2021 and earlier Chevrolet Express and GMC Savana vans.

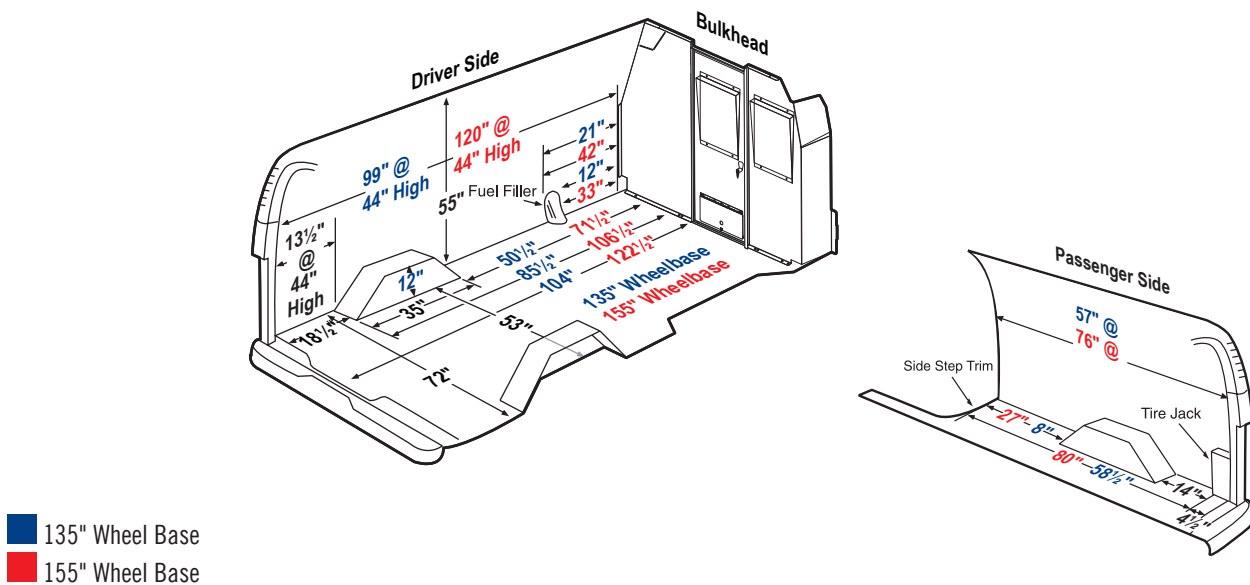

Note: Verify the location of the gas tank, brake lines, wiring harness, etc. before installing any equipment.

# VAN INTERIOR DIMENSIONS FITTING GUIDE

## IMPORTANT UPFIT TIPS

- Always measure your van carefully to make sure that the equipment you choose will fit properly.
- Verify the location of the gas tank, brake lines, wiring harness, etc. before installing any equipment.
- Shelving Mounting Kits are recommended.
- Do not exceed the van manufacturer's roof load rating.

### RAM PROMASTER®

The dimensions show in this guide refer to model year 2021 and earlier RAM Promaster vans.

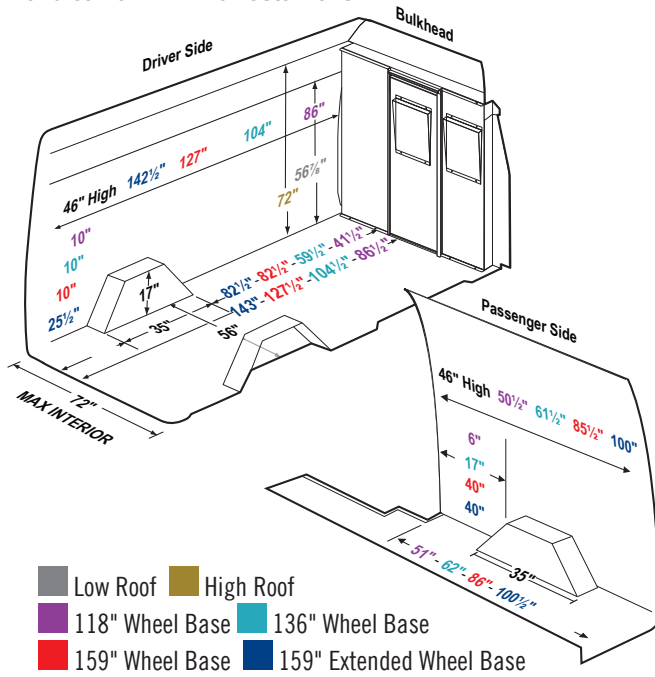

### RAM PROMASTER CITY™

The dimensions show in this guide refer to model year 2021 and earlier RAM ProMaster City vans.

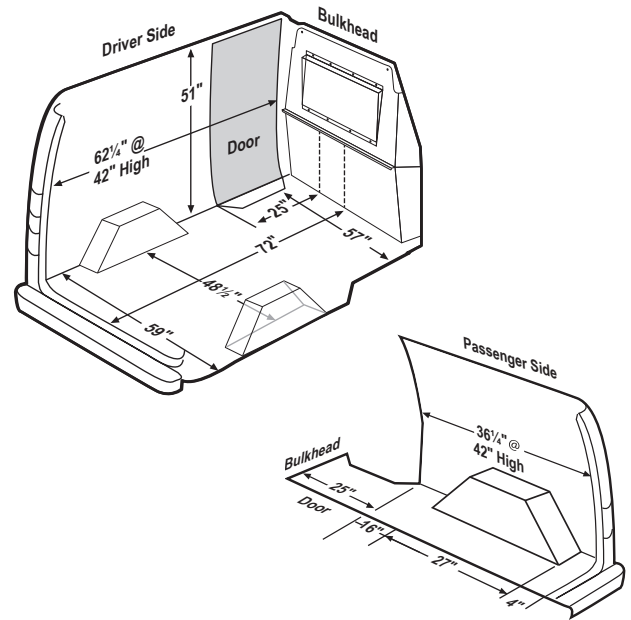

### MERCEDES / FREIGHTLINER / DODGE SPRINTER

The dimensions show in this guide refer to model year 2007-2021 Sprinter NV vans.

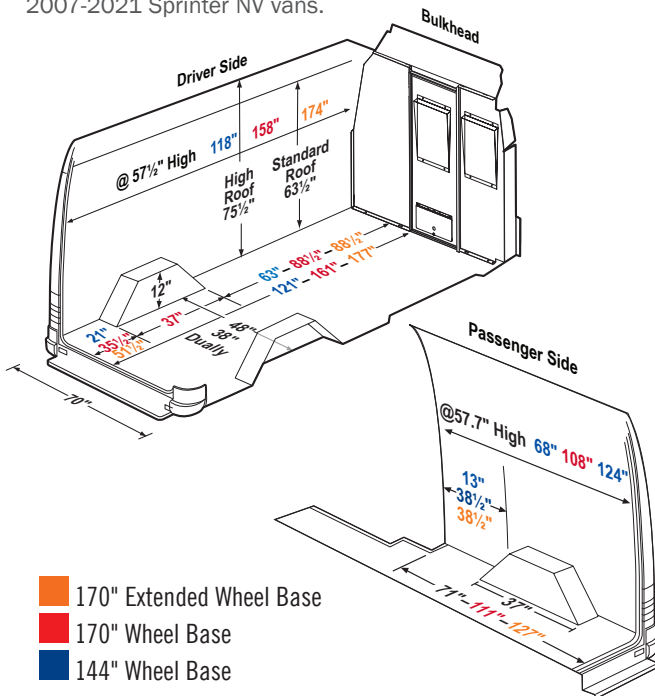

### MERCEDES METRIS

The dimensions show in this guide refer to model year 2021 and earlier Mercedes Metris vans.

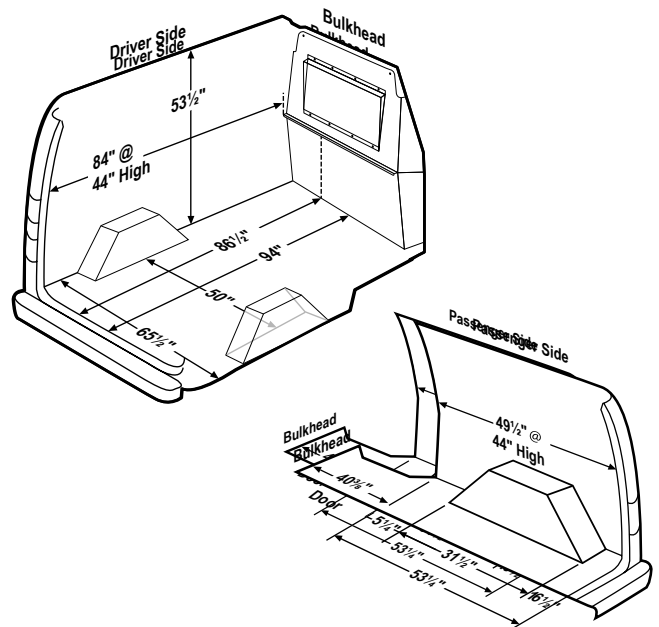

Note: Verify the location of the gas tank, brake lines, wiring harness, etc. before installing any equipment.

# BASIC VAN CONFIGURATIONS

## Simplify your Selection and Maximize your Space

Take the guess work out of what products to select with this simple guide to get the most shelving space in your commercial van. This is a great starting point in developing your storage solution. See below for the steel bulkhead and shelving combinations that best fits your van.



\*The RED numbers below correspond to the number of units to be ordered per SKU number.

DESCRIPTION & SKU	SHELVING								BULKHEADS										
	9353-3-03 (3 Shelf - 36")	9354-3-03 (3 Shelf - 42")	9355-3-03 (3 Shelf - 52")	9356-3-03 (3 Shelf - 60")	9373-3-03 (4 Shelf - 36")	9374-3-03 (4 Shelf - 42")	9375-3-03 (4 Shelf - 52")	9376-3-03 (4 Shelf - 60")	96102-3-01 (Steel Bulkhead - SCRNI)	96111-3-02 (Mesh Bulkhead-TC)	96112-3-01 (Mesh Bulkhead - PMC)	96113-3-01 (Mesh Bulkhead - MBM)	96114-3-01 (Mesh Bulkhead - CHCE)	96122-3-01 (Steel Bulkhead - SCRNI)	96142-3-01 (Steel Bulkhead - SCRNI)	96202-3-01 (Steel Bulkhead - SCRNI)	96302-3-01 (Steel Bulkhead - SCRNI)	96312-3-01 (Steel Bulkhead - SCRNI)	96322-3-01 (Steel Bulkhead - SCRNI)
<b>FULL-SIZE CONFIGURATIONS</b>																			
<b>FORD</b>																			
Transit LR, 130"		2	1																1
Transit LR, 148"		1	1	1														1	
Transit MR 130"						2	2												
Transit MR 148"						1	1	1											1
Transit HR 148"						1	1	1											1
Transit HR Ext					2			2											1
<b>GM/CHEVROLET</b>																			
LR 135		2	1						1										
LR 155		1	1	1					1										
<b>NISSAN</b>																			
NV LR 146		2	1															1	
NV HR 146						2	1						1						
<b>RAM</b>																			
ProMaster LR 118					1	2													1
ProMaster LR/HR 136						1	2												1
ProMaster HR 159							2	1											1
ProMaster HR 159 EXT					2			2											1
<b>MERCEDES</b>																			
Sprinter 144						1	1	1											1
Sprinter 170					2			2											1
Sprinter 170 EXT					2			2											1
<b>COMPACT CONFIGURATIONS</b>																			
<b>FORD</b>																			
Transit Connect	2									1									
<b>GM/CHEVROLET</b>																			
City Express	2												1						
<b>NISSAN</b>																			
NV200	2												1						
<b>RAM</b>																			
PM City	2										1								
<b>MERCEDES</b>																			
Metris	1	2										1							

# BULKHEADS

Our Full-Size and Compact van bulkheads provide a safe barrier between the van's cab and the cargo area for maximum protection against shifting loads. Available options include various window options for improved visibility, doors for cargo area access and pass throughs to expand cargo storage. WEATHER GUARD® Bulkheads are designed for all commercial van types and sizes, from high-roof, full size vans to compact vans. Several bulkhead accessories are available to keep you organized.

## CABMAX™ COMPOSITE BULKHEAD

WEATHER GUARD® CABMAX™ Composite Bulkhead provides custom organization, increased cab space and noise reduction.

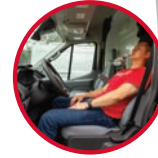
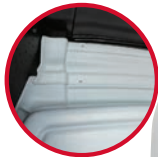

CAB SIDE

### TIGHT FIT

Improves climate control and reduces noise.

### INCREASED CAB SPACE

Allows for full seat travel with maximized recline. Provides additional storage and work space.

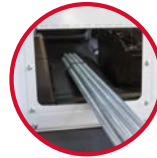

CARGO SIDE

### WINDOW ACCESSORY

Allows for added visibility.

### DOG HATCH™ DOOR ACCESSORY

Allows for use of additional cab floor storage for long materials. (Full Size Vans Only)

### CUSTOMIZED ORGANIZATION

Accessory panels allow for customized organization options on the cab and cargo sides. (Full Size Vans Only)

## CABMAX™ COMPOSITE BULKHEAD

### CABMAX™ Composite Bulkhead for Chevy/GM/Ford/Mercedes/Ram

MODEL	DESCRIPTION	WEIGHT
96100-3-01	CABMAX™ - GMC Savana/Chevrolet Express	83 lbs.
96120-3-01	CABMAX™ - Mercedes Sprinter Standard Roof	80 lbs.
96123-3-01	CABMAX™ - Mercedes Sprinter High Roof	85 lbs.
96140-3-01	CABMAX™ - RAM ProMaster Lo/Hi Roof	85 lbs.
96300-3-01	CABMAX™ - Ford Transit Low Roof	75 lbs.
96310-3-01	CABMAX™ - Ford Transit Mid-Roof/High-Roof Base	83 lbs.
96320-3-01	CABMAX™ - Ford Transit High-Roof Header Panel, Requires 96310-3-01	4 lbs.
96501-3-01	CABMAX™ - Ford Transit Connect	60 lbs.
96502-3-01	CABMAX™ - RAM ProMaster City	60 lbs.
96503-3-01	CABMAX™ - Mercedes Metris	60 lbs.

### CABMAX™ Composite Bulkhead Accessories

MODEL	DESCRIPTION	WEIGHT
96905-3-01	Bulkhead Accessory Panels (2-pack)	5 lbs.
96906-3-01	Window Accessory for Full Size Vans	5 lbs.
96907-3-01	Window Accessory for Compact Vans	10 lbs.
96908-3-01	Dog Hatch™ Door Accessory for Full Size Vans	5 lbs.
70004R	CABMAX™ Accessory Installation Template - Full Size Van	6 lbs.
70015R	CABMAX™ Window Accessory Installation Template - Compact Vans	10 lbs.



COMING SOON

COMING SOON



# STEEL BULKHEADS



Model 96102-3-01

Model 96101-3-01

## Chevy/GM/Ford Econoline Full Size Van Bulkhead

Offers improved visibility and a large area to mount accessories while providing safety and security for occupants and cargo.

MODEL	DESCRIPTION	WEIGHT
96101-3-01	Window Bulkhead	65 lbs.
96102-3-01	Screen Bulkhead	65 lbs.
96901-3-01	Hinge Kit converts bulkhead to swinging door with lockable latch	4 lbs.
96903-3-01	Solid Bulkhead Panel Adapter kit	10 lbs.



Model 96114-3-01

Model 96514-3-01

## Compact Van Bulkhead

Window bulkheads offer unobstructed visibility of the cargo area, side door, and rear door. Maximizes comfort in the passenger area. Lightweight mesh bulkheads deliver full driver and cargo protection.

MODEL	DESCRIPTION	WEIGHT
96514-3-01	Window Bulkhead - City Express	40 lbs.
96114-3-01	Mesh Bulkhead - City Express	35 lbs.



Deep offset bulkheads for Ford Transit vans provides full seat travel and extra legroom. Designated by a "D" at the end of the part number.



Model 96321-3-01

Model 96322-3-01

## Ford Transit Van High-Roof Bulkhead

MODEL	DESCRIPTION	WEIGHT
96321-3-01	Window Bulkhead - Transit (high-roof)	108 lbs.
96322-3-01	Screen Bulkhead - Transit (high-roof)	108 lbs.
96321-3-01D	Deep Offset Window Bulkhead - Transit (high-roof)	111 lbs.
96322-3-01D	Deep Offset Screen Bulkhead - Transit (high-roof)	111 lbs.
96901-3-01	Hinge Kit converts bulkhead to swinging door with lockable latch	4 lbs.
96903-3-01	Solid Bulkhead Panel Adapter Kit	10 lbs.

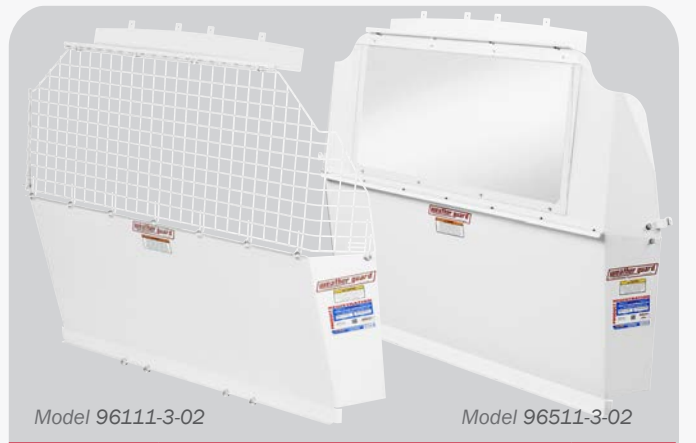

Model 96111-3-02

Model 96511-3-02

## Ford Transit Connect Van Bulkhead

Window bulkheads offer unobstructed visibility of the cargo area, side door, and rear door. Maximizes comfort in the passenger area. Lightweight mesh bulkheads deliver full driver and cargo protection.

MODEL	DESCRIPTION	WEIGHT
96511-3-02	Window Bulkhead** - Transit Connect	40 lbs.
96111-3-02	Mesh Bulkhead - Transit Connect	35 lbs.

\*\*Ford Transit Connect (2010 - 2013 model years) use -01 instead of -02

See above for Ford Econoline.



Deep offset bulkheads for Ford Transit vans provides full seat travel and extra legroom. Designated by a "D" at the end of the part number.



Model 96301-3-01

Model 96302-3-01



Model 96311-3-01

Model 96312-3-01

### Ford Transit Van Low-Roof Bulkhead

MODEL	DESCRIPTION	WEIGHT
96301-3-01	Window Bulkhead - <i>Transit (low-roof)</i>	67 lbs.
96302-3-01	Screen Bulkhead - <i>Transit (low-roof)</i>	67 lbs.
96301-3-01D	Deep Offset Window Bulkhead - <i>Transit (low-roof)</i>	70 lbs.
96302-3-01D	Deep Offset Screen Bulkhead - <i>Transit (low-roof)</i>	70 lbs.
96901-3-01	Hinge Kit converts bulkhead to swinging door with lockable latch	4 lbs.
96903-3-01	Solid Bulkhead Panel Adapter kit	10 lbs.

### Ford Transit Van Mid-Roof Bulkhead

MODEL	DESCRIPTION	WEIGHT
96311-3-01	Window Bulkhead - <i>Transit (mid-roof)</i>	108 lbs.
96312-3-01	Screen Bulkhead - <i>Transit (mid-roof)</i>	108 lbs.
96311-3-01D	Deep Offset Window Bulkhead - <i>Transit (mid-roof)</i>	111 lbs.
96312-3-01D	Deep Offset Screen Bulkhead - <i>Transit (mid-roof)</i>	111 lbs.
96901-3-01	Hinge Kit converts bulkhead to swinging door with lockable latch	4 lbs.
96903-3-01	Solid Bulkhead Panel Adapter Kit (for all full size bulkheads)	10 lbs.



Mercedes-Benz



Model 96122-3-01

Model 96121-3-01

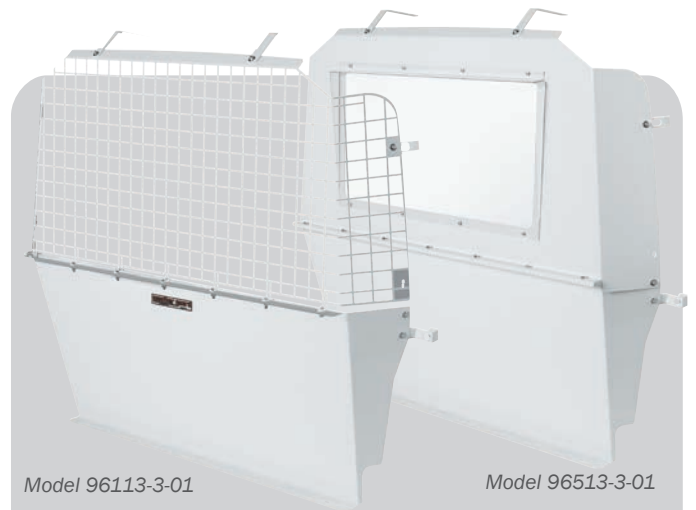

Model 96113-3-01

Model 96513-3-01

### Bulkhead for Sprinter Standard/High Roof

Offers improved visibility and a large area for accessory mounts and holders while providing safety and security for occupants and cargo. Includes header panels for standard and high roof bans.

MODEL	DESCRIPTION	WEIGHT
96121-3-01	Window Bulkhead - <i>Sprinter</i>	105 lbs.
96122-3-01	Screen Bulkhead - <i>Sprinter</i>	105 lbs.
96901-3-01	Hinge Kit converts bulkhead to swinging door with lockable latch	4 lbs.
96903-3-01	Solid Bulkhead Panel Adapter (for all full or high-roof bulkheads)	10 lbs.

### Bulkhead for Metris

Window bulkheads offer unobstructed visibility of the cargo area, side door, and rear door. Maximizes comfort in the passenger area. Lightweight mesh bulkheads deliver full driver and cargo protection.

MODEL	DESCRIPTION	WEIGHT
96113-3-01	Mesh Bulkhead - <i>Metris</i>	69 lbs.
96513-3-01	Window Bulkhead - <i>Metris</i>	69 lbs.

WEATHER GUARD® EXCLUSIVE!



Redesigned RAM ProMaster bulkheads now offer increased leg room and full seat travel.



**BULKHEADS**

### RAM ProMaster® Standard/High Roof Bulkhead

Offers improved visibility and a large area for accessory mounts and holders while providing safety and security for occupants and cargo. Includes header panels for standard and high roof bars.

MODEL	DESCRIPTION	WEIGHT
96141-3-01	Window Bulkhead - ProMaster®	105 lbs.
96142-3-01	Screen Bulkhead - ProMaster®	105 lbs.
96901-3-01	Hinge Kit converts bulkhead to swinging door with lockable latch	4 lbs.
96903-3-01	Solid panel adapter kit for all full and high roof bulkheads	10 lbs.

### Bulkhead for Ram ProMaster City™

Window bulkheads offer unobstructed visibility of the cargo area, side door, and rear door. Maximizes comfort in the passenger area. Lightweight mesh bulkheads deliver full driver and cargo protection.

MODEL	DESCRIPTION	WEIGHT
96112-3-01	Mesh Bulkhead, Ram ProMaster City™	35 lbs.
96512-3-01	Window Bulkhead, Ram ProMaster City™	40 lbs.

## STEEL BULKHEAD ACCESSORIES

### Steel Bulkhead Swing Door Conversion Kit

Convert the center panel of a full-size van bulkhead into a swinging door with the Model 96901-3-01 Swing Door Conversion Kit. This kit includes hinges and a door handle with a lock.

This kit is compatible with Models 96101-3-01, 96102-3-01, 96121-3-01, 96141-3-01, 96142-3-01, 96201-3-01, 96301-3-01, 96301-3-01D, 96302-3-01, 96302-3-01D, 96311-3-01, 96311-3-01D, 96312-3-01, 96312-3-01D, 96321-3-01, 96321-3-01D, 96322-3-01, and 96322-3-01D van bulkheads.



MODEL	DESCRIPTION	WEIGHT
96901-3-01	Swing Door Conversion Kit - Steel Bulkhead, Full Size Vans	3 lbs.

Model 96901-3-01

## REDZONE ACCESSORIES FOR THE BULKHEAD

WEATHER GUARD® Bulkhead Accessories let you create a custom storage solution that securely organizes the items you need to locate quickly and easily.

### Bulkhead Accessories\*

MODEL	DESCRIPTION	WEIGHT
1 9879-7-01	Tool Organizer	3 lbs.
2 8875	Hard Hat Bracket	2 lbs.
3 8866	Fire Extinguisher	6 lbs.
4 8877-3	Practice Holder	4 lbs.
5 96901-3-01	Hinge Kit	4 lbs.
6 96903-3-01	Solid Panel Kit	10 lbs.



Check out REDZONE Accessories starting on page 15 for more details



## ADJUSTABLE SHELVING

Durable, professional grade WEATHER GUARD® Van Shelving takes it to the max! Maximum customization and capacity, for maximum productivity. Shelves can be adjusted quickly without removing them from the van. Assembly and installation is faster and easier than before. Customize your storage solution with shelving accessories starting on page 16.

**WEATHER GUARD® EXCLUSIVE!**



### TAPERED END PANEL CLOSER FIT

for more working space inside the van



### DEEP FULLY HEMMED SHELVES

sized for tools, equipment, and other materials

### EASY TO CUSTOMIZE

with pre-punched mounting holes for WEATHER GUARD® accessories and cabinets

### EASY TO ASSEMBLE AND INSTALL

with captive nuts on each shelf and complete installation hardware



### ADJUSTABLE DIVIDERS

Includes pack of four adjustable dividers for each shelf

### PUNCHED SHELVES

for easier installation of accessory cabinets

### FRONT FLOOR CLEARANCE

(16" SHELVES ONLY)

for material storage. Fits PACK RAT® Drawer Units

### UNMATCHED DURABILITY

achieved with heavy duty 18 gauge steel construction

### FLAT FRONTS

on 13-1/2" deep adjustable shelves. Mount doors and accessories at floor level

### Shelf Units: Ships complete in one carton

MODEL	DEPTH	HEIGHT	WIDTH	SHELVES	DIVIDERS	WEIGHT
9333-3-03	13½"	34"	36"	2	8	48 lbs.
9334-3-03	13½"	34"	42"	2	8	48 lbs.
9335-3-03	13½"	34"	52"	2	8	72 lbs.
9336-3-03	13½"	34"	60"	2	8	70 lbs.
9352-3-03	13½"	44"	28"	3	12	50 lbs.
9353-3-03	13½"	44"	36"	3	12	53 lbs.
9354-3-03	13½"	44"	42"	3	12	57 lbs.
9355-3-03	13½"	44"	52"	3	12	66 lbs.
9356-3-03	13½"	44"	60"	3	12	73 lbs.
9373-3-03	13½"	60"	36"	4	16	76 lbs.
9374-3-03	13½"	60"	42"	4	16	94 lbs.
9375-3-03	13½"	60"	52"	4	16	110 lbs.
9376-3-03	13½"	60"	60"	4	16	136 lbs.
9343-3-03	16"	44"	36"	3	12	74 lbs.
9344-3-03	16"	44"	42"	3	12	80 lbs.
9345-3-03	16"	44"	52"	3	12	85 lbs.
9346-3-03	16"	44"	60"	3	12	104 lbs.
9363-3-03	16"	60"	36"	4	16	92 lbs.
9364-3-03	16"	60"	42"	4	16	94 lbs.
9365-3-03	16"	60"	52"	4	16	110 lbs.
9366-3-03	16"	60"	60"	4	16	136 lbs.

### 24" Deep Jumbo Shelving Items

Extra deep 24" shelving constructed of 18-gauge steel and finished with durable brite white powder coat. These shelves are easy to assemble and provide the perfect foundation for a customized van or trailer.



MODEL	HEIGHT	WIDTH	DEPTH	SHELVES
8393-3-01	59½"	42¼"	24"	3
8394-3-01	59½"	51¼"	24"	3
8395-3-01	59½"	69¼"	24"	3
8118-3-01	Short Bin Dividers for 24"D shelves			

# MOUNTING KITS AND SHELF COMPONENTS



- Unique 4-way stop combines mounting straps with steel brackets to resist front to back and side to side movement when driving
- Secure installation – extruded aluminum upper mounting rail and steel brackets spread shelf load across van wall
- Easily position and install shelves with patent-pending twist-in plate mounting system
- Open Floor Mounting – no floor rail to interfere with storing wide or bulky items under the bottom shelf
- Compatible with OEM wall liners



- Faster, easier, more secure and safer installation
- Kit mounts shelf units directly to reinforced weld nuts or factory holes in the van, without drilling any new holes
- Heavy duty steel mounting plates distribute shelf load inside van
- No-drill installation method for installation time savings

## Full-Size Van Shelf Mounting Kits

Mounting kits include upper rails, mounting plates, and hardware for two shelf units on driver side (three shelf units for extended vans) and one shelf on passenger side..

MODEL	MODEL	DESCRIPTION	WEIGHT
975101-3-01	Ford Transit	130" WB low-roof	30 lbs.
975102-3-01	Ford Transit	148" WB low-roof	32 lbs.
975103-3-01	Ford Transit	130" WB mid-roof	19 lbs.
975104-3-01	Ford Transit	148" WB mid/high-roof	19 lbs.
975105-3-01	Ford Transit	148" XWB high-roof	23 lbs.
975201-3-01	RAM ProMaster	118" WB low-roof	18 lbs.
975202-3-01	RAM ProMaster	136" WB low/high-roof	17 lbs.
975203-3-01	RAM Promaster	159" WB high-roof	19 lbs.
975204-3-01	RAM Promaster	159" XWB high-roof	27 lbs.
975301-3-01	Mercedes Sprinter	144" WB low/high-roof	19 lbs.
975302-3-01	Mercedes Sprinter	170" WB high-roof	25 lbs.
975401-3-01	Express/Savana	135" WB low-roof	18 lbs.
975402-3-01	Express/Savana	155" WB low-roof	20 lbs.

## Divider Sets *Keep things on the shelf in place*

MODEL	HEIGHT	WIDTH	DIVIDERS	WEIGHT
9820	2"	10"	4	2 lbs.
9825	2"	13½"	4	2 lbs.
9826	2"	16"	4	2 lbs.
9825T	6"	13½"	4	3 lbs.
9826T	6"	16"	4	4 lbs.

## Compact Van Shelf Mounting Kits

Driver side and passenger side Mounting Kits include mounting plates and hardware to install a 36" and a 28" wide shelf unit along the inside wall of the van Rear Mounting Kits include mounting plates and hardware to install two 36" wide shelf units over the wheel wells in the rear of the van.

MODEL	MODEL	WEIGHT
975106-3-01	Ford Transit Connect - Driver Side	15 lbs.
975107-3-01	Ford Transit Connect - Passenger Side	15 lbs.
9751-3-01	Ford Transit Connect - Rear	11 lbs.
975205-3-01	RAM ProMaster City - Driver Side	15 lbs.
975206-3-01	RAM ProMaster City - Passenger Side	15 lbs.
9752-3-01	RAM ProMaster City - Rear	19 lbs.
9753-3-01	Mercedes Metris - Driver and Passenger Side	13 lbs.

## Extra Shelves *Includes one set of dividers*

MODEL	HEIGHT	WIDTH	DEPTH	WEIGHT
9122-3-01	2"	28"	10½"	14 lbs.
9123-3-01	2"	36"	10½"	14 lbs.
9124-3-01	2"	42"	10½"	18 lbs.
9125-3-01	2"	52"	10½"	22 lbs.
9126-3-01	2"	60"	10½"	26 lbs.
9142-3-01	2"	28"	13½"	14 lbs.
9143-3-01	2"	36"	13½"	14 lbs.
9144-3-01	2"	42"	13½"	18 lbs.
9145-3-01	2"	52"	13½"	22 lbs.
9146-3-01	2"	60"	13½"	26 lbs.
9163-3-01	2"	36"	16"	14 lbs.
9164-3-01	2"	42"	16"	18 lbs.
9165-3-01	2"	52"	16"	22 lbs.
9166-3-01	2"	60"	16"	26 lbs.
8080-3-01	3"	42"	24"	x lbs.
8081-3-01	3"	51¼"	24"	x lbs.
8082-3-01	3"	69¼"	24"	x lbs.

## Shelf Center Support *Increase shelf load capacity with a set of center supports. One support included with each 60" wide shelf set.*

MODEL	HEIGHT	WIDTH	DEPTH	WEIGHT
9740-3-01	44"	1.2"	1.2"	9 lbs.
9760-3-01	60"	1.2"	1.2"	9 lbs.

# SHELVING ACCESSORIES

## A Shelf Doors with High Security D Handle Lock

MODEL	HEIGHT	SHELF WIDTH	WEIGHT
9502-3-01	11"	28"	10 lbs.
9503-3-01	11"	36"	13 lbs.
9504-3-01	11"	42"	17 lbs.
9505-3-01	11"	52"	21 lbs.
9506-3-01	11"	60"	25 lbs.

**Light Weight Shelf Back Panels** (not shown)  
use with shelf doors to turn a shelf into a cabinet

MODEL	HEIGHT	SHELF WIDTH	WEIGHT
9602-3-02	7¾"	28"	2 lbs.
9603-3-02	7¾"	36"	2 lbs.
9604-3-02	7¾"	42"	3 lbs.
9605-3-02	7¾"	52"	4 lbs.
9606-3-02	7¾"	60"	5 lbs.
9602-3-01	14½"	28"	4 lbs.
9603-3-01	14½"	36"	4 lbs.
9604-3-01	14½"	42"	6 lbs.
9605-3-01	14½"	52"	8 lbs.
9606-3-01	14½"	60"	10 lbs.

## B Retainer Lips keeps items in place under shelf units

MODEL	HEIGHT	SHELF WIDTH	DEPTH	WEIGHT
9702-3-02	1½"	28"	1½"	1 lb.
9703-3-02	1½"	36"	1½"	1 lb.
9704-3-02	1½"	42"	1½"	1 lb.
9705-3-02	1½"	52"	1½"	2 lbs.
9706-3-02	1½"	60"	1½"	2 lbs.

Required to use Nissan NV Floor Mounting Points

## C Divider Sets keep things on the shelf in place

MODEL	HEIGHT	SHELF DEPTH	DIVIDERS	WEIGHT
9820	2"	10"	4	2 lbs.
9825	2"	13½"	4	2 lbs.
9826	2"	16"	4	2 lbs.
9825T	6"	13½"	4	3 lbs.
9826T	6"	16"	4	4 lbs.

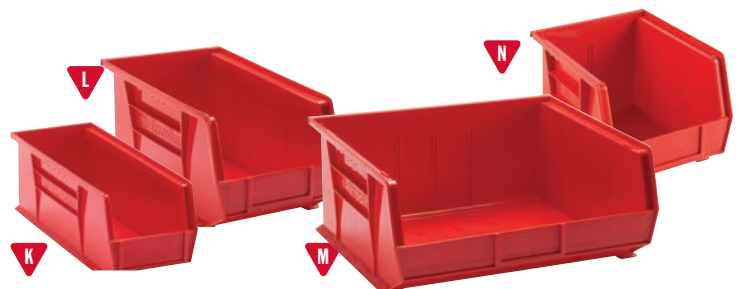

## Accessories End panel and shelf

MODEL	DESCRIPTION	WEIGHT
E 8866	Fire Extinguisher	6 lbs.
F 8875	Hard Hat Bracket	2 lbs.
G 8841	Shelf Mat (13.5" deep shelves)	1 lb.
H 9832	Shelf Mat (13" & 10½ deep shelves)	1 lb.
I 9836	Shelf Mat (16" deep shelves)	1 lb.
J 9880-3-01	Literature Holder	11 lbs.

## Bin Sets sturdy plastic bins sized to fit new van shelving

MODEL	HEIGHT	WIDTH	DEPTH	BINS	WEIGHT
K 9854-7-01	5"	5½"	14¾"	9	1 lb.
L 9855-7-01	7"	8¼"	14¾"	6	1 lb.
M 9856-7-01	7"	16½"	14¾"	3	1 lb.
9858-7-01	5"	5½"	10⅞"	9	8 lbs.
N 9859-7-01	7"	8¼"	10⅞"	6	8 lbs.

# REDZONE ACCESSORIES

Looking for parts and supplies won't slow you down with new and re-engineered REDZONE van storage accessories. Organizers and holders keep frequently used items in easy reach for maximum productivity. Tool cabinets, parts bin boxes, and locking storage keep small components organized.

## CUSTOMIZED ORGANIZATION

for supplies and tools



## BUCKET AND TANK HOLDERS



## HEAVY DUTY 18 GAUGE STEEL CONSTRUCTION

makes for tough, long lasting accessories



## POWDER COAT FINISH

provides durability



## HOOKS AND BRACKETS

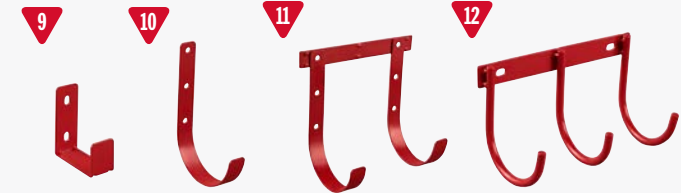

## EASY TO INSTALL

to shelf end panels, bulkheads, and door



SHELVING

## REDZONE Accessories

	MODEL	DESCRIPTION	HEIGHT	WIDTH	DEPTH	WEIGHT
1	9874-7-01	Can Organizer	9.8"	12"	4"	3 lbs.
2	9879-7-01	Tool Organizer	5½"	15"	4"	3 lbs.
3	9881-7-01	Caulk Tube Tray	7½"	13½"	7½"	4¼ lbs.
4	9882-7-01	Wire Spool Holder End Mount	26"	14"	6"	12 lbs.
5	9883-7-01	Large Parts Bin	11"	13"	7"	10 lbs.
6	9884-7-01	Medium Parts Bin	6½"	13"	7"	8 lbs.
7	9885-7-01	5 Gallon Bucket Holder	6¾"	11¼"	11¼"	8 lbs.
8	9886-7-01	30# Refrigerant Tank Holder	10¾"	9¾"	9¾"	9 lbs.
9	9887-7-01	Ladder Holder	4"	1½"	3½"	¼ lb.
10	9891-7-01	Large Hook (5" diameter)	8"	1¼"	5"	½ lb.
11	9892-7-01	2 Hook Holder (5" diameter)	8"	9"	5"	½ lb.
12	9893-7-01	3 Hook Cord or Tool Holder	5¼"	9"	4½"	½ lb.

# EZ-CUBE WELDED SHELVING

Heavy-duty van storage, made easy. Our fully arc-welded WEATHER GUARD® EZ-Cube Shelving is pre-assembled and ready to install. Pre-punched shelves allow for quick installation of cabinets, bin dividers, or accessory doors. Heavy-gauge steel construction with our signature bright white powder coat ensure years of durability, and a professional appearance.

## TAPERED END PANEL DESIGN

allows a close fit to the van wall and additional cargo space in the middle of the van

## FULLY ARC WELDED

for durable construction and no assembly

## HEMMED SHELVES

provide extra strength and a lip in front of the shelf for load retention

## BOTTOM SHELF IS PRE-PUNCHED

for EZ installation of accessory cabinets



## MIDDLE TWO SHELVES ARE PRE-PUNCHED

for EZ Bin Dividers

## BOTTOM RETAINER LIP

is made of durable, heavy gauge steel

## EZ SHELF DOORS

turns bottom shelf into a cabinet



EZ Bin Dividers mount to two middle shelves

## EZ-Cube for Full-Size Vans

MODEL	SHELVES	HEIGHT	WIDTH	TOP DEPTH	BOTTOM DEPTH	WEIGHT
9400-3-01	4	43¾"	42"	11¼"	13¾"	76 lbs.
9452-3-01	4	43¾"	51"	11¼"	13¾"	90 lbs.

## Accessories for EZ-Cube Shelving

MODEL	DESCRIPTION	WEIGHT
8401-3-01	EZ Bin Dividers (8)	18 lbs.
8841	EZ Shelf Mat ( <i>trim to fit</i> )	1 lb.
8502-3-01	EZ Shelf Door (42" wide X 10" high)	17 lbs.
8503-3-01	EZ Shelf Door (51" wide X 10" high)	20 lbs.



## Wheel Well Base Cabinet

Designed to fit over the wheel well and provide a flat, sturdy foundation for Shelf Units, Parts Cabinets, or Drawer Units.

MODEL	HEIGHT	WIDTH	DEPTH	WEIGHT
9444-3-01	13¾"	42¾"	15"	49 lbs.



# POWERSYNC™ VAN SHELF LIGHTING

WEATHER GUARD® Van Shelf Lighting provides better storage visibility with built-in PowerSync™ freedom.

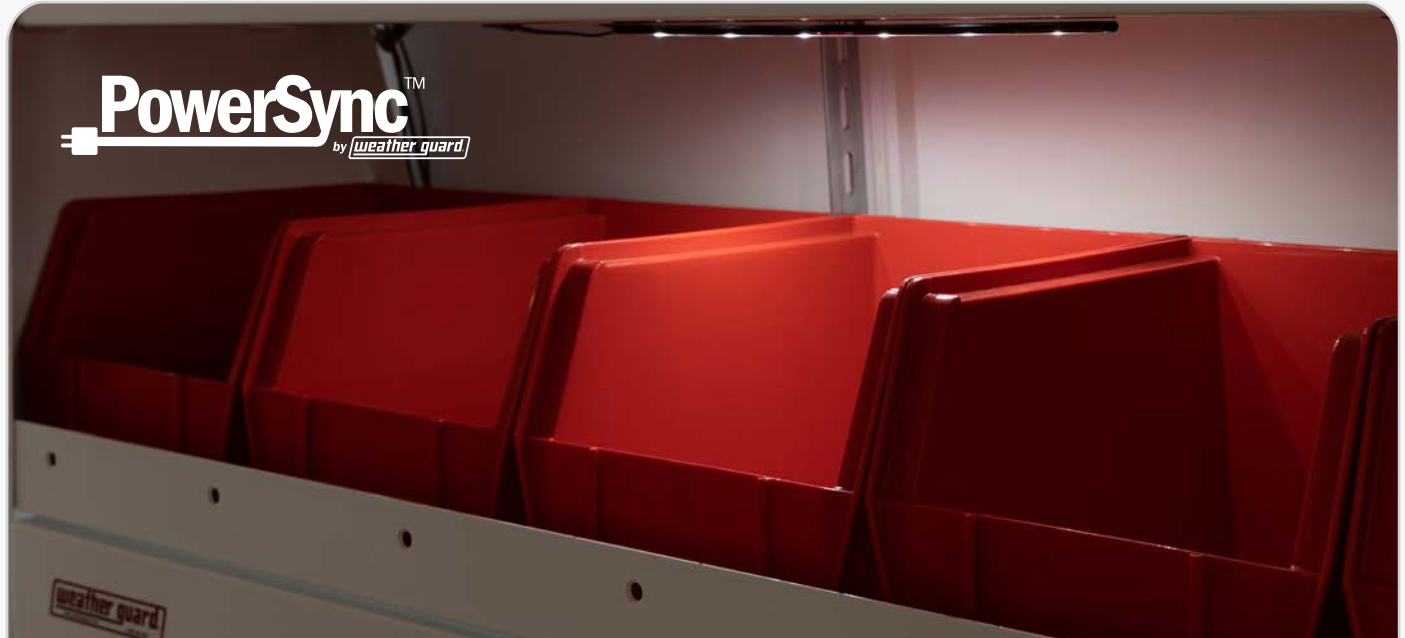

SHELVING

## EASY INSTALLATION OF POWERSYNC™ VAN LIGHTING

Terminals connect directly to the van battery and lights are activated by a switch that can be mounted to the van's shelf or bulkhead.

## INCREASE VISIBILITY

Low profile, commercial grade LED light strips brighten each shelf in the van storage area.

## CUSTOMIZE TO YOUR VEHICLE

Lights can be placed in any location on the shelves to provide the ideal solution for the user.

## COMPATIBLE WITH STANDARD VAN SHELVING

The PVK001 Kit includes enough lighting for 3 shelving units. Order multiple kits or additional models separately for added customization.

## WHAT'S INCLUDED IN THE

### PowerSync™ Van Shelf Lighting Kit

Van configurations with up to three shelving units can be outfitted by the PowerSync™ Van Shelf Lighting Kit, Part No. PVK001.

MODEL	DESCRIPTION
PVK001	PowerSync™ Van Shelf Lighting Kit

#### KIT INCLUDES:

- (1) PPC001 Power Cable
- (1) PEC001 Extension Cable
- (3) PLK001 Shelf Lighting Harnesses
- Cable Management Components

Weight (lbs)	Height (in)	Length (in)	Width (in)
2	3	15	4

## VAN WIRE DIAGRAM

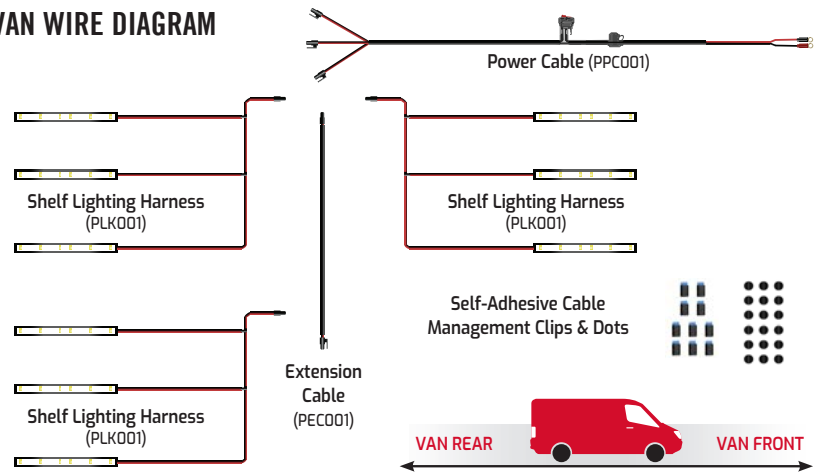

## AVAILABLE ADD-ONS FOR

### PowerSync™ Van Shelf Lighting

To add-on to the Van Shelf Lighting Kit, or to create custom configurations, these SKUs may be purchased separately.

MODEL	DESCRIPTION
PPC001	Power Cable
PEC001	Extension Cable
PLK001	Shelf Lighting Harness



#### POWER CABLE (PPC001)

168" long cable connects easily to the battery with included ring terminals or can be spliced into van's lighting system with integrated rocker switch.



#### EXTENSION CABLE (PEC001)

100", sheathed cable connects passenger side shelf lighting to power cable on passenger side.



#### SHELF LIGHTING HARNESS (PLK001)

Includes three, 12" LED light bars connected to the main line with 24" cables for location customization.



# SPECIALTY STORAGE

## SECURE STORAGE

Add extra security and theft-resistance for valuable tools and equipment with WEATHER GUARD® Secure Storage shelf units. Multiple door and drawer modules easily assemble into WEATHER GUARD® Shelving.

### HIGH SECURITY

Securely store tools and materials with our heavy duty locking mechanism. Latch operated drawers stay closed when the vehicle is in motion

### FUNCTIONALITY

Our largest drawers for maximum storage capacity.

### CUSTOMIZATION

Allows placement that best suits your needs with our stackable secure storage modules.

### FAST AND EASY ASSEMBLY

16" deep cabinet easily installs on 16" deep shelving. Designed to seamlessly fit 42" wide shelves.

Shelving Unit  
Sold Separately



## STEP 1 SELECT INDIVIDUAL SHELVING UNIT TO FIT YOUR VAN



9344-3-03



9364-3-03

Check out Shelf Units on page 12 for more details.

## STEP 2 SELECT THE STORAGE MODULE TO FIT YOUR NEEDS

### Secure Storage Modules

MODEL	DESCRIPTION	WEIGHT
Storage Module Only (For 42" Wide Shelf Units Order Separately)		
902-3-01	2 Drawer Storage Module	38 lbs.
903-3-01	3 Drawer Storage Module	44 lbs.
9045-3-03	5 Drawer Storage Module	82 lbs.



902-3-01



903-3-01



9045-3-03

# CABINETS

High quality, durable Drawer Cabinets feature latches for each drawer, smooth ball-bearing rollers, and secure locks that can be keyed alike. Bin Cabinets feature hook and loop fasteners to securely hold bins in place.



## Mechanics Grade Tool Cabinets

High quality and durable mechanics grade tool cabinets for your van feature easy-to-grip handles and smooth ball-bearing rollers.

	MODEL	DRAWERS	HEIGHT	WIDTH	DEPTH	WEIGHT
1	9912-3-02*	2	12"	16"	13.7"	26 lbs.
2	9914-3-02*	4	12"	16"	13.7"	32 lbs.
3	9924-3-02*	4	24"	16"	13.7"	48 lbs.
4	9928-3-02	8	24"	16"	13.7"	60 lbs.
5	9984-3-01	4	24"	18"	13.7"	53 lbs.
6	9988-3-01	8	24"	18"	13.7"	60 lbs.

\* Order Mounting Kit 9994 for secure assembly to shelf



SECURE LOCK

DRAWER LATCH

SPECIALTY STORAGE

## Divider Kits

MODEL	DESCRIPTION	WEIGHT
9822-3-01	Divider Kit for Shallow Drawers	2 lbs.
9824-3-01	Divider Kit for Deep Drawers	2 lbs.

Keep shelf facing up with the Cabinet Mounting Spacer Kit Model 9994.



SPACER KIT



Invert shelf when assembling it and mount cabinet directly to shelf.

## Cabinet Accessory Mounting

MODEL	DESCRIPTION	WEIGHT
9994	Cabinet Mounting Spacer Kit (13½" and 16" deep shelves)	1 lb.
9996-3-01	Mounting Bracket Kit (16" shelves)	1 lb.

Great for securing electronics or expensive equipment. Our new locking storage cabinets feature secure locking D-Handles and tool-less reversible doors.

## Stackable Locking Storage Cabinets

MODEL	SHELVES	HEIGHT	WIDTH	DEPTH	WEIGHT
1	N/A	22"	18"	16"	25 lbs.
2	2*	22"	18"	16"	35 lbs.

\*Removable Shelves



# SMALL PARTS STORAGE

1



2



3



4



VELCRO KEEPS BINS IN PLACE

5



6



## Small Parts Storage

Fits on all 13.5" and 16" deep WEATHER GUARD® shelves for unlimited placement. Includes easy alignment connecting straps for simple assembly.

MODEL	DESCRIPTION	HEIGHT	WIDTH	DEPTH	WEIGHT
1	9909-3-02 9 Bin Parts Cabinet	12"	17"	11¾"	28 lbs.
2	9918-3-03 18 Bin Parts Cabinet	12"	32½"	11¾"	54 lbs.
3	9960-3-01 Three Shelf, Stackable Cabinet with Three (3) Small Parts Organizer Cases (9961-9-01)	16.9"	18.6"	15.2"	30 lbs.
4	9961-9-01 Small Parts Organizer Case	6.3"	18.1"	15.3"	1 lb
5	9962-3-01* Two Shelf, Stackable Cabinet	16.9"	18.6"	15.2"	27 lbs.
6	9963-3-01 Under-Shelf/End Panel Bracket with Small Parts Organizer Case (9961-9-01)	6.3"	18.1"	15.3"	9 lbs.

# FLOOR STORAGE - PACK RAT® DRAWER UNITS

Have your equipment waiting for you as soon as you open the door. These heavy-duty pull-out drawer units can be mounted inside the side or rear door openings. They offer easy access to hundreds of pounds of tools and supplies, while leaving floor space open for hauling materials or moving in and out of the vehicle.

## ANTI-SKID STRIPS

Provide traction for wet and muddy boots



## POWER PASS® ELECTRICAL PASS-THRU

Grommet for easy for tool charging



## ONE TOUCH LATCH

Red pushbutton allows for one hand operation

Model 310-3-01

## HEAVY GAUGE ALUMINUM

Strong, but light, with a 225 pound load rating

## SMOOTH ROLLING DRAWER

For easy access and organization

## EASY MAINTENANCE

Removable drawers to clean, lubricate, and service

WEATHER GUARD® EXCLUSIVE!



## 14-GAUGE STEEL

on top and sides allows for a 750 lb. load rating when evenly distributed on top of unit

## 12-GAUGE STEEL SKIDS

and full width ribs underneath and inside the unit add extra strength

## SMOOTH ROLLING DRAWER

provides trouble free operation and handles up to 425 lbs. of equipment



\*Part No. 9858-7-01 fits inside this cabinet model

SPECIALTY STORAGE

# FLOOR STORAGE - PACK RAT® DRAWER UNITS



Tool Drawer

MODEL	HEIGHT	WIDTH	DEPTH	COMPARTMENTS	WEIGHT
310-3-01	17¾"	12¼"	42"	1	56 lbs.

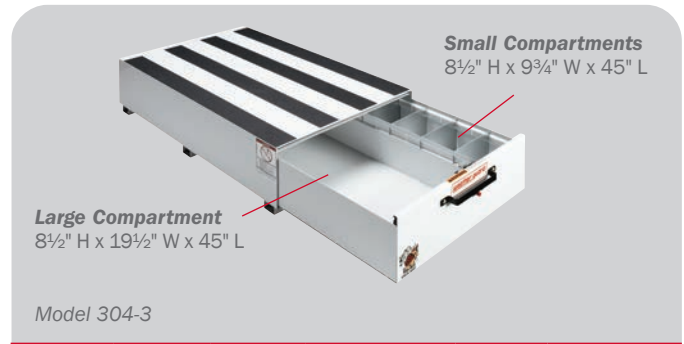

Extra Wide Compartment 48" Long Drawer Unit

MODEL	HEIGHT	WIDTH	COMPARTMENTS	DIVIDERS	WEIGHT
304-3	9½"	30"	2	6	220 lbs.
334-3	13"	30"	2	6	245 lbs.

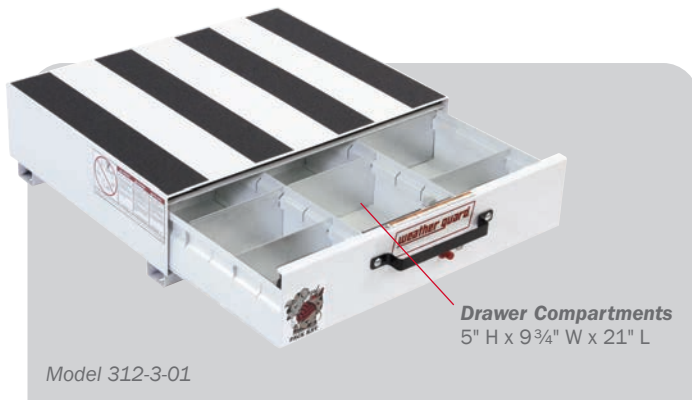

9½" High x 24" Long Drawer Unit

MODEL	WIDTH	COMPARTMENTS	DIVIDERS	WEIGHT
312-3	30"	3	12	151 lbs.

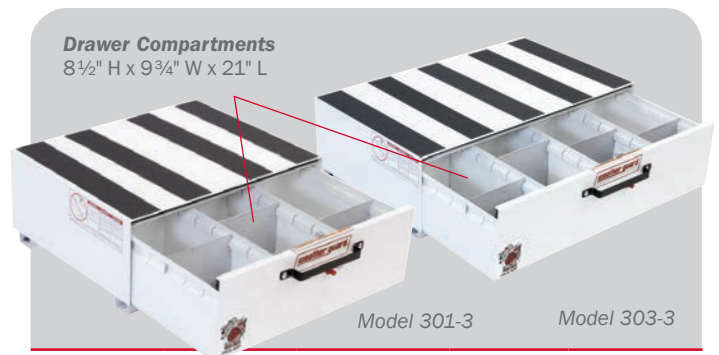

13" High x 24" Long Drawer Units

MODEL	WIDTH	COMPARTMENTS	DIVIDERS	WEIGHT
301-3	30"	3	12	169 lbs.
303-3	39¾"	4	12	217 lbs.

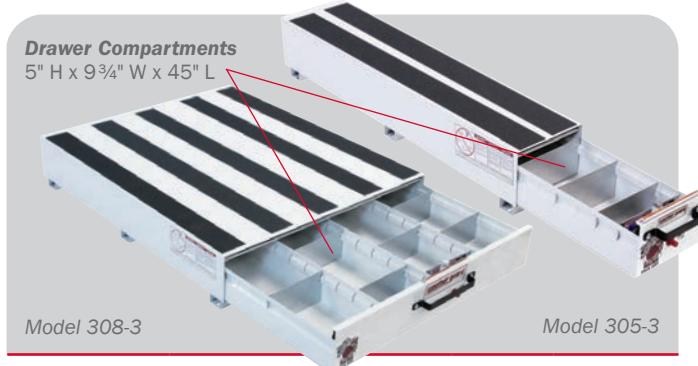

9½" High x 48" Long Drawer Units

MODEL	WIDTH	COMPARTMENTS	DIVIDERS	WEIGHT
305-3	10¼"	1	6	106 lbs.
306-3	20"	2	12	179 lbs.
307-3	30"	3	18	247 lbs.
308-3 (white)	39¾"	4	24	322 lbs.
308-5 (black)	39¾"	4	24	322 lbs.

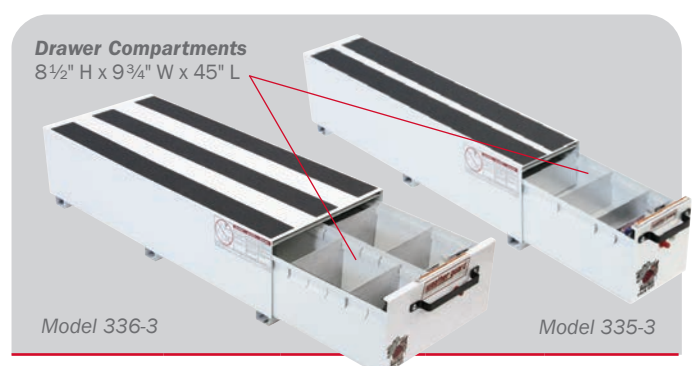

13" High x 48" Long Drawer Units

MODEL	WIDTH	COMPARTMENTS	DIVIDERS	WEIGHT
335-3	10¼"	1	6	130 lbs.
336-3	20"	2	12	210 lbs.
337-3	30"	3	18	294 lbs.
338-3 (white)	39¾"	4	24	383 lbs.
338-5 (black)	39¾"	4	24	383 lbs.

# FLOOR STORAGE - ITEMIZER® DRAWER UNITS

This exclusive, lightweight aluminum storage solution conveniently increases your storage space by placing small equipment at your fingertips without the need to crawl inside the van. Drawer dividers provide an extensive array of organizing options.

## LIGHTWEIGHT ALUMINUM DRAWERS

carry up to 75 lbs. of equipment each

## UNITS CAN BE STACKED

as needed for additional storage

## ROLLER MOUNTED DRAWERS

glide open to full extension

## ADJUSTABLE DRAWER DIVIDERS

offer greater flexibility



Model 318-3

## ANTI-SKID STRIPS

provides traction for wet and muddy boots

## LOCK MOUNT

is provided for installation of optional camlock

Model 314-3

1 Drawer

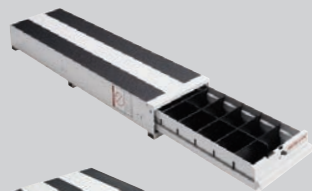

Model 316-3

2 Drawer Lateral



Model 317-3

3 Drawer Lateral

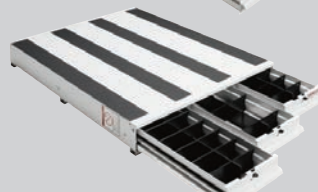

Model 318-3

4 Drawer Lateral

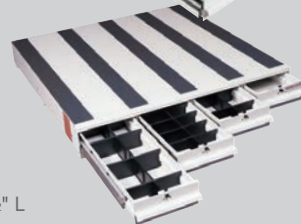

### Drawer Compartments

4 1/4" H x 10 1/2" W x 46 1/2" L

Model 326-3

2 Drawer Stacked

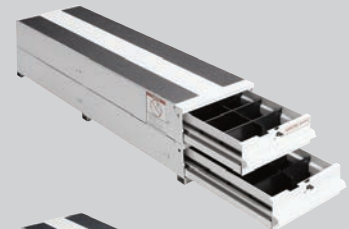

Model 327-3

3 Drawer Stacked



Model 328-3

4 Drawer Stacked



### Drawer Compartments

4 1/4" H x 10 1/2" W x 46 1/2" L

## Lateral Drawer Units

MODEL	DRAWERS	HEIGHT	WIDTH	DEPTH	WEIGHT
314-3	1	6 3/4"	12 1/4"	49"	26 lbs.
316-3	2 Lateral	6 3/4"	24"	49"	55 lbs.
317-3	3 Lateral	6 3/4"	36"	49"	85 lbs.
318-3	4 Lateral	6 3/4"	48"	49"	110 lbs.

## Stacked Drawer Units

MODEL	DRAWERS	HEIGHT	WIDTH	DEPTH	WEIGHT
326-3	2 Stacked	12 1/4"	12 1/4"	49"	48 lbs.
327-3	3 Stacked	17 3/4"	12 1/4"	49"	71 lbs.
328-3	4 Stacked	23 1/2"	12 1/4"	49"	92 lbs.

SPECIALTY STORAGE

## TANK HOLDERS & FLOOR MOUNTED



You're a professional, a specialist. You need specific equipment to keep at the top of your game. WEATHER GUARD® Van Solutions has what you need. Tank and cable racks, and catalog table units.

### Floor Mounted Accessories

MODEL	DESCRIPTION	HEIGHT	WIDTH	DEPTH	WEIGHT
1	9861-3-01 Cable Spool Holder	42½"	19¾"	16¼"	37 lbs.
2	9862-3-01 Tank Holder 3 - 50 lb.	45½"	15½"	8"	31 lbs.
3	9863-3-01 Tank Holder 2 - 30 lb., 1 - 50 lb.	40"	15½"	8"	27 lbs.
4	9864-3-01 Tank Holder 4 - 30 lb.	48½"	13"	8"	31 lbs.
5	9860-3-01 Catalog File Unit	36"	6"	12"	16 lbs.

## DOOR STORAGE



These door organizers keep tools and supplies close by. No digging around inside the van for those items used on every job. Durable steel trays and lids keep everything in place while driving. Adjustable dividers let you customize. You not only build or repair, but educate and inform customers. Catalog and literature holders keep information at hand, for your customers or crews.

### Door Trays and Literature Holders

MODEL	HEIGHT	WIDTH	DEPTH	WEIGHT
1	21¾"	20¼"	4⅝"	19 lbs.
2	21¾"	20¼"	4⅝"	18 lbs.
3	16"	13"	5"	11 lbs.



# CAB COMMAND CENTER

Rethought and repurposed. Not a file box, but a between-seat Cab Command Center! Plenty of room for your laptop and hanging files. Handy clip board on lid and extra storage for personal items. Power Pass® electrical pass-thru grommet lets you keep everything charged while you're on the road. Our D-Handle lock keeps everything safe when you're on the job. Easy to release interior latch lets you take it when you need it. Use Model 9010-3-01 for Ford Transit, Ram ProMaster® vans and Model 9012-3-01 for Sprinter, GM and Ford E-Series vans.

**WEATHER GUARD® EXCLUSIVE!** 



**HIDDEN LATCH TO BASE**  
means only you can remove it from your vehicle

**POWER PASS® ELECTRICAL PASS-THRU GROMMET**  
allows you to charge items within the box

**RAISED MOUNTING BASE FOR 6" FLOOR CLEARANCE**  
with tamper-resistant Torx® head mounting bolts

**SIMPLIFIED INSTALLATION**  
gets you back on the job quickly

**SECURE D HANDLE LOCKS**  
single point latching for theft-resistance

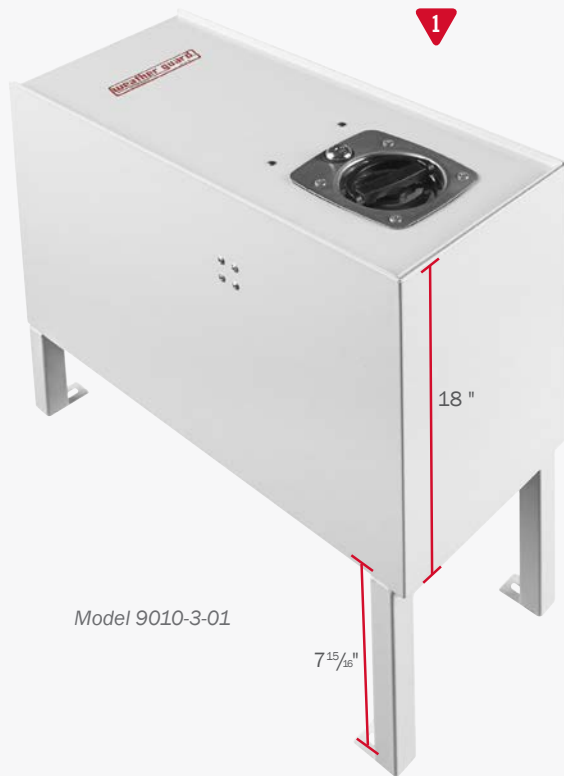

Model 9010-3-01



Model 9012-3-01

**SPECIALTY STORAGE**

**1 Cab Command Center for Ford Transit and RAM ProMaster®**

MODEL	HEIGHT	WIDTH	DEPTH	WEIGHT
9010-3-01	18"	7½"	20"	30 lbs.

**2 Cab Command Center for Sprinter, Express, Savana and E-Series**

MODEL	HEIGHT	WIDTH	DEPTH	WEIGHT
9012-3-01	12"	13"	20"	30 lbs.

# ROOF RACKS

## EZGlide2™ DROP-DOWN LADDER RACK

### EASIEST TO OPERATE

50% less effort to operate than competitor drop-down ladder racks, reducing strain on the operator

### LIGHTEST WEIGHT

Drop-down ladder rack available

- Maximize fuel economy
- Maximize carrying capacity

### MOST VERSATILE

- Up to 40' extension ladders
- 5' - 10' stepladders
- Conduit carriers

### STOW AND SECURE

Interlocking ladder supports ensure ladders stay in place when stowed

### INCREASED PRODUCTIVITY

Get ladders off your van on the job faster and reduce worker fatigue and injuries



LADDER LOCK BRACKET



EASY REMOVAL



TWO FINGER OPERATION

SAFE OPERATION



### STEP 1 CHOOSE A MOUNTING KIT

(Mounting Kits are not needed for Chevy Express, GMC Savana or Ford E-Series. See Step 2)

#### Mounting Channel Kits

All Mounting Channel Kits attach to factory mounting points. No drilling required. All hardware included.

MODEL	DETAILS	WEIGHT
2102-0-01	Mounting Channel Kit - Ford Transit 148" and XWB	15 lbs.
2130-0-01	Mounting Channel Kit - Ford Transit 130" WB	12 lbs.
2113-0-01	Mounting Channel Kit - Sprinter, Nissan NV Low Roof	15 lbs.
2115-0-01	Mounting Channel Kit - Ram ProMaster®	15 lbs.
2085-0-01	Compact Kit - Ford Transit Connect, Chevy City Express, RAM ProMaster City™, Mercedes Metris, Nissan NV200, Nissan NV High Roof	15 lbs.
2505	Service Body Kit - Knapheide, Reading and similar service bodies	9 lbs.



Model 2102-0-01

## STEP 2 SELECT A DROP-DOWN LADDER RACK

(Single-Side Only with Crossmembers)

Model 2291-3-01



• Mounting kit not included

### Drop-Down Ladder Rack

Drop-down can mount on driver or passenger side. Rack fits 16' to 40' Extension, 5' to 10' Step and 3' to 8' Podium, evenly distributed on ladder rack. Carry ladders appropriate to the size of the vehicle.

MODEL	PRODUCT	DETAILS	WEIGHT
2291-3-01	Extended Drop-Down Mid/High-Roof Vans	Includes Two 70" Cross Members which can be set at 96" or 77" center to center	77 lbs.
2271-3-01	Fixed Drop-Down Full Size Vans	Includes Two 70" Cross Members which can be set at 96" or 77" center to center	77 lbs.
2261-3-01	Fixed Drop-Down Compact Vans	Includes Two 60" Cross Members which can be set at 77" center to center	83 lbs.

## OPTIONAL ADD A DROP-DOWN LADDER RACK ACCESSORY

Model 2295-3-01



Model 2277-3-01

• Mounting kit not included

### Drop-Down Ladder Rack Accessories

Long ladder kits fit 16' to 40' Extension, 5' to 10' Step and 3' to 8' Podium, evenly distributed on ladder rack. Short ladder kits include a center cross member to carry shorter ladders on opposite side of rack.

MODEL	PRODUCT	DETAILS	WEIGHT
2295-3-01	Extended Drop-Down Long Ladder Kit Mid/High-Roof Vans	For Cross Members set at 96" or 77" center to center. Installs to 2291-3-01 (Cross-members not included)	48 lbs.
2297-3-01	Extended Drop-Down Short Ladder Kit Mid/High-Roof Vans	Includes 70" Cross Member which can be set at 42" center to center. Installs to 2291-3-01	55 lbs.
2275-3-01	Fixed Drop-Down Long Ladder Kit - Full Size Vans	For Cross Members set at 96" or 77" center to center. Installs to 2271-3-01 (Cross-members not included)	51 lbs.
2277-3-01	Fixed Drop-Down Short Ladder Kit Full Size Vans	Includes 70" Cross Member which can be set at 42" center to center. Installs to 2271-3-01	57 lbs.
2265-3-01	Fixed Drop-Down Long Ladder Kit Compact Vans	For Cross Members set at 77" center to center. Installs to 2261-3-01 (Cross-members not included)	58 lbs.
2267-3-01	Fixed Drop-Down Short Ladder Kit Compact Vans	Includes 60" Cross Member which can be set at 42" center to center. Installs to 2261-3-01	61 lbs.

Always properly secure ladders to the ladder rack while driving. Transporting ladders longer than the vehicle is not recommended.

### Accessories

MODEL	DETAILS	WEIGHT
2501	Warning Light Holder	3 lbs.
2254D-3-01	Quick Clamp Add-On Kit (Driver Side)	13 lbs.
2254P-3-01	Quick Clamp Add-On Kit (Passenger Side)	13 lbs.
2060-3-01	Accessory Cross Member (Compact Vans 60" Wide)	6 lbs.
2070-3-01	Accessory Cross Member (Full Size Vans 70" Wide)	6 lbs.

Model 2254D-3-01  
Driver Side Kit



Model 2070-3-01  
70" Accessory Cross Member

# QUICK CLAMP ALUMINUM RACKS

Quick Clamp Aluminum Racks engineered to fit *Full-Size Vans* and Compact Vans. Not recommended for vans with roof heights above 84 inches.

WEATHER GUARD® EXCLUSIVE! 

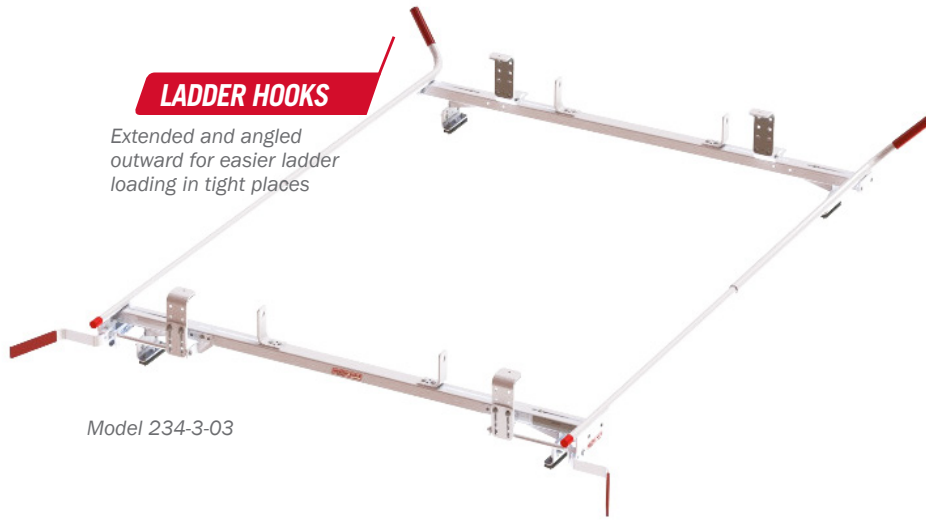

## LADDER HOOKS

Extended and angled outward for easier ladder loading in tight places

Model 234-3-03

## WEATHER GUARD® VAN SOLUTIONS TRADEMARKED RED TIPS

show the world that you work with the highest quality equipment available

## LONG LASTING DESIGN

utilizing a 70" extruded aluminum rail and stainless steel hardware. Designed for use with WEATHER GUARD® mounting channel kits or gutter clamps. Gas springs with internal brass bushings prevent strip-out

## ANTI-WEAR PROTECTION

on clamps helps protect ladders during transport

# QUICK CLAMP RACK AND ACCESSORY CROSS MEMBER



Patented Quick Clamp Rack clamping mechanism can be locked with a padlock for security.



Works with model 234-3-03 and 236-3-03 Quick Clamp Racks to accommodate short ladders and provide additional support.



## Quick Clamp Rack for Full Size Vans

MODEL	DETAILS	WEIGHT
234-3-03	Quick Clamp Rack - 70" Dual	58 lbs.
236-3-03	Quick Clamp Rack - 70" Single (curb side only)	48 lbs.
223-3-03	Quick Clamp Rack - 60" Single (curb side only)	44 lbs.
224-3-03	Quick Clamp Rack - 60" Dual	54 lbs.

## Quick Clamp Rack - Full Size Accessory Cross Member

MODEL	DETAILS	WEIGHT
233-3-03	Quick Clamp Rack - 70" Accessory Cross Member	19 lbs.
225-3-03	Quick Clamp Rack - 60" Accessory Cross Member	16 lbs.



Model 2102-0-01

## Mounting Channel Kits

All Mounting Channel Kits attach to factory mounting points. No drilling required. All hardware included.

MODEL	DETAILS	WEIGHT
2102-0-01	Mounting Channel Kit Ford Transit 148" and XWB	15 lbs.
2130-0-01	Mounting Channel Kit Ford Transit 130" WB	12 lbs.
2113-0-01	Mounting Channel Kit Sprinter, Nissan NV Low Roof	15 lbs.
2115-0-01	Mounting Channel Kit Ram ProMaster®	15 lbs.
2085-0-01	Compact Kit Ford Transit Connect, Chevy City Express, RAM ProMaster City™, Mercedes Metris, Nissan NV200, Nissan NV High Roof	15 lbs.
2505	Service Body Kit Knapheide, Reading and similar service bodies	9 lbs.

# ALUMINUM RACKS - FULL-SIZE VANS WITH SIDE GUTTERS

Our Quick Clamp Racks are engineered to make loading and unloading your ladder an easy one-person operation by leaning the front of the ladder against the front hook and swinging it up onto the rack. Close the gas spring assisted Quick Clamp and you're ready to roll. Designed for Chevrolet Express, GMC Savana and Ford E-Series Vans.

## LADDER HOOKS

Extended and angled outward for easier ladder loading in tight places

**WEATHER GUARD®**  
**VAN SOLUTIONS**  
**TRADEMARKED RED TIPS**  
 show the world that you work with the highest quality equipment available



**LONG LASTING DESIGN**  
 utilizing a 70" extruded aluminum rail and stainless steel hardware. Designed for use with WEATHER GUARD® mounting channel kits or gutter clamps. Gas springs with internal brass bushings prevent strip-out

**ANTI-WEAR PROTECTION**  
 on clamps helps protect ladders during transport



## GUTTER CLAMP



Mounting leg attaches to the van with a stainless steel gutter clamp painted brite white.

## QUICK CLAMP



Patented Quick Clamp Rack clamping mechanism can be locked with a padlock for security.

## ADDITIONAL SUPPORT



Center mounting leg provides additional support and stability.

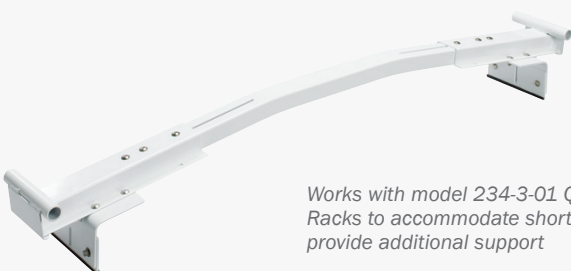

Works with model 234-3-01 Quick Clamp Racks to accommodate short ladders and provide additional support

## Accessory Cross Member for Full Size Vans

MODEL	DETAILS	WEIGHT
233-3-01	Fits Models 234-3-01, 236-3-01	21 lbs.

## Quick Clamp Rack for Full Size Vans

MODEL	DETAILS	WEIGHT
234-3-01	Dual Clamp Rack (street side/curb side)	76 lbs.

ROOF RACKS

# ALL-PURPOSE STEEL VAN RACK

**ADJUSTABLE GUIDES & STOPS**  
No tools needed with easy-grip handles

**DURABILITY**  
All Steel construction with powder coat paint finish. Industry leading 3-bar load capacity\*

**PROTECTION**  
Anti-wear cross member stripping protects ladder and materials against damage

**AIR FOIL**  
Reduces wind noise

**GLIDESAFE™ LOAD ASSIST**  
Helps with loading and unloading. Protects roof from damage.

**RATCHET STRAP ACCESSORY**  
Simplifies and strengthens material tie down

**MOUNTING OPTIONS**  
Direct to OEM mounting points or WG Roof Rails

\*Load capacity = 1,000lbs. Always follow OEM roof capacity requirements.

## All-Purpose Steel Van Racks

MODEL	DESCRIPTION	WEIGHT
20501-3-01	All-Purpose Steel Van Rack 2 Bar – Full Size Van (Ford, Nissan, Ram, Sprinter)	60 lbs.
21501-3-01	All-Purpose Steel Van Rack 3 Bar – Full Size Van (Ford, Nissan, Ram, Sprinter)	85 lbs.
22001-3-01	All-Purpose Steel Van Rack 2 Bar – Compact Van (Ford, GM, Nissan, Ram)	44 lbs.
22002-3-01	All-Purpose Steel Van Rack 2 Bar – Compact Van (Metris)	45 lbs.

## Steel Van Rack Accessories

MODEL	DESCRIPTION	WEIGHT
22101-3-01	Accessory Cross Member, Compact Van (Ford, GM, Nissan, Ram)	22 lbs.
22102-3-01	Accessory Cross Member, Compact Van (Metris)	23 lbs.
22001-3-01	Accessory Cross Member, Full Size Van (Ford, Nissan, Ram, Sprinter)	30 lbs.
23001-3-01**	GlideSafe™ Rear Load Assist System, Full Size Van (Ford, Nissan, Ram, Sprinter)	33 lbs.
23003-3-01**	GlideSafe Rear Load Assist System, Compact Van	24 lbs.
23004-3-01**	GlideSafe™ Rear Load Assist System, Full Size Van (For Models 205-3/216-3)	26 lbs.
23101-3-01	Ratchet Straps (2-Pack) w/Mounting Brackets for All Purpose Steel Van Rack	9 lbs.
23103-7-01	Accessory Ladder Guide	2 lbs.
23104-7-01	Accessory Ladder Stop	3 lbs.

\*\*Requires third cross member for installation.

# ALL-PURPOSE RACKS

Versatile and rugged, our All-Purpose Racks create a space for all the long equipment you need to carry. Available in aluminum or steel, WEATHER GUARD® Roof Racks offer a number of different mounting and accessory options.

## STEP 1 CHOOSE A MOUNTING KIT

(Mounting Kits are not needed for Chevy Express, GMC Savana or Ford E-Series. See Step 2)

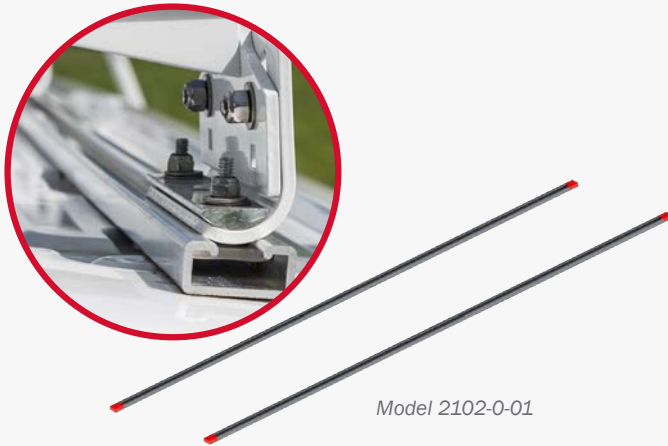

### Mounting Channel Kits

All Mounting Channel Kits attach to factory mounting points. No drilling required. All hardware included.

MODEL	DETAILS	WEIGHT
2102-0-01	Mounting Channel Kit Ford Transit 148" and XWB	15 lbs.
2130-0-01	Mounting Channel Kit Ford Transit 130" WB	12 lbs.
2113-0-01	Mounting Channel Kit Sprinter, Nissan NV Low Roof	15 lbs.
2115-0-01	Mounting Channel Kit Ram ProMaster®	15 lbs.
2085-0-01	Compact Kit Ford Transit Connect, Chevy City Express, RAM ProMaster City™, Mercedes Metris, Nissan NV200, Nissan NV High Roof	15 lbs.
2505	Service Body Kit Knapheide, Reading and similar service bodies	9 lbs.

## STEP 2 SELECT ALL PURPOSE RACK & ACCESSORY CROSS MEMBERS

### Powder Coated Aluminum Rack for Full-Size Vans



MODEL	DETAILS	WEIGHT
209-3-03	70" All Purpose Rack	35 lbs.
2097-3-03	70" All Purpose Accessory Cross Member	43 lbs.

Ford E-Series, Chevy Express, & GMC Savana do not require a mounting channel kit

### Powder Coated Aluminum Rack for Compact Vans

MODEL	DETAILS	WEIGHT
218-3-03	60" All Purpose Aluminum Van Rack	31 lbs.
222-3-03	60" All Purpose Accessory Cross Member	17 lbs.

### Powder Coated Heavy Duty Steel Rack for Chevy Express, GMC Savana, Ford E-Series

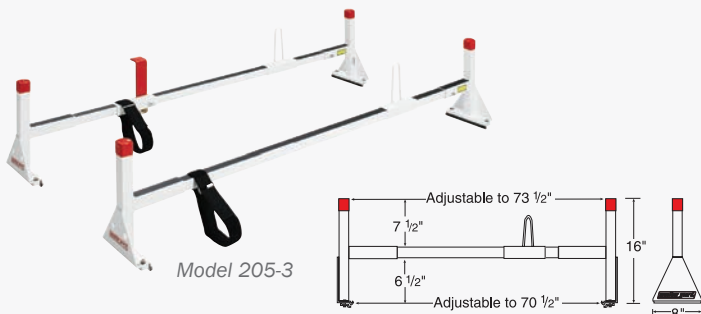

MODEL	DETAILS	WEIGHT
205-3	2 Cross Member Rack - White	42 lbs.
216-3	3 Cross Member Rack - White	62 lbs.
2056-3	Accessory Cross Member - White	23 lbs.

## SAFARI RACK - FULL-SIZE VANS

Excellent for hauling all types of materials, the Safari Rack easily accommodates 4-foot wide loads and distributes the weight evenly over eight cross members to protect the roof of the van. **Fits GMC Savana, Chevy Express, Ford E-Series** only.

### FRONT & REAR CROSS MEMBERS

extend over the ends of the van for protection when loading ladders and other long materials

### ANTI-WEAR PROTECTION

on cross members helps protect ladders and building materials during transport

### CROSS MEMBERS

are constructed of 13-gauge, 1½" x 1¼" square steel tubing and spread the load evenly to protect long, fragile materials

### AIR FOIL

eliminates wind noise and mounts to the front of the cross member

### STAINLESS STEEL MOUNTING BRACKETS

are extra wide for superior attachment strength to the gutter

### VELCRO STRAPS

assist in securing your ladder for transport

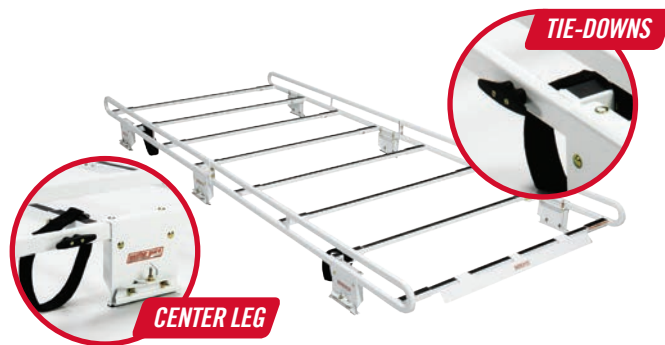

Safari Rack

MODEL	DETAILS	LENGTH	WIDTH	HEIGHT	WEIGHT
210-3	Safari Rack	140"	64"	150¾"	205 lbs.

For GMC Savanam Chevy Express, Ford E-Series vans only.

## SLIDING LADDER RACK

Our Sliding Ladder Rack provides quick and easy ladder storage inside your van, enclosed trailer, or cube van. Rugged and durable, this rack fits 8-foot step, extension, or multi-position ladders up to 80 lbs. mounted to the roof. Updated for easy mounting to Transit and ProMaster vans.

### UNIVERSAL MOUNTING BRACKET

adjusts to different vehicles

### 3-PIECE RAIL ASSEMBLY

accepts up to an 8' ladder

### NEW ROOF MOUNTING BRACKET

for Transit and ProMaster installation

### ADJUSTABLE CRADLE

accommodates different types of ladders

### TENSION CORD GUIDE

prevents cords from tangling

### SAFETY CABLE

secures ladder in place



Sliding Ladder Rack

MODEL	DETAILS	LENGTH	WIDTH	HEIGHT	WEIGHT
250	Sliding Ladder Rack	46½"	17"	13¾"	30 lbs.

## CONDUIT CARRIERS

### Aluminum Conduit Carrier

mounts to all Weather Guard Ladder Racks

MODEL	DETAILS	LENGTH	WIDTH	HEIGHT	WEIGHT
237	Conduit Carrier	121½"	11"	6"	40 lbs.
238	Extension	6"	11"	6"	4 lbs.

(Mounts to EZGLIDE™ with third Cross Member.)

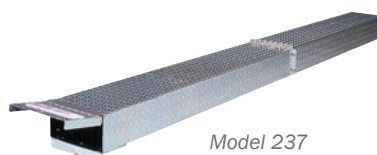

Model 237

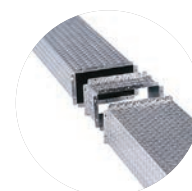

Model 238

### Make-Your-Own Conduit Carrier

MODEL	WEIGHT
239	4 lbs.

PVC not included. Separately purchase a section of standard 6" PVC (ASTM D2665) plastic drain pipe. Coordinate the length of the PVC with the length of conduit you'll be carrying.

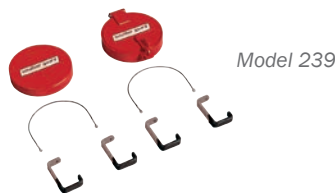

Model 239



# ROOF RACK FITTING GUIDE



VEHICLE TYPE MODEL YEARS	FULL-SIZE VANS								COMPACT VANS						OTHER	
	Low-roof				Mid-/High-roof				Ford Transit Connect 2010-2013	Ford Transit Connect 2014+	Ram ProMaster City™ 2015-Present	Chevrolet City Express 2015-Present	Nissan NV200 2014-2021	MercedesMetris 2016-Present	Service Bodies	Box Trucks/Trailers
	Ford Transit 2015-Present	Ford E-Series 1992 - 2013	Chevrolet Express 1996-Present	GMC Savana 1996-Present	Nissan NV 2011-2021	Ford Transit 2015-Present	Ram ProMaster® 2014-Present	Mercedes Sprinter 2007-Present								
<b>MOUNTING KITS</b>																
2085-0-01		N/R	N/R	N/R					X	X	X	X	X	X	X	
2102-0-01	X <sup>2</sup>	N/R	N/R	N/R		X <sup>2</sup>										
2130-0-01	X <sup>2</sup>	N/R	N/R	N/R		X <sup>2</sup>										
2113-0-01		N/R	N/R	N/R	X		X									X
2115-0-01		N/R	N/R	N/R			X									
2505		N/R	N/R	N/R												X
<b>EZGLIDE2™ DROP-DOWN LADDER RACKS</b>																
2261-3-01									X	X	X	X	X	X	X	
2265-3-01									X	X	X	X	X	X	X	
2267-3-01									X	X	X	X	X	X	X	
2271-3-01	X	X <sup>1</sup>	X <sup>1</sup>	X <sup>1</sup>	X											
2275-3-01	X	X <sup>1</sup>	X <sup>1</sup>	X <sup>1</sup>	X											
2277-3-01	X	X <sup>1</sup>	X <sup>1</sup>	X <sup>1</sup>	X											
2291-3-01						X	X	X	X						X	X
2295-3-01						X	X	X	X						X	X
2297-3-01						X	X	X	X						X	X
<b>ALUMINUM QUICK CLAMP RACKS</b>																
223-3-03									X	X	X	X	X	X	X	
224-3-03									X	X	X	X	X	X	X	
233-3-01		X <sup>1</sup>	X <sup>1</sup>	X <sup>1</sup>												
234-3-01		X <sup>1</sup>	X <sup>1</sup>	X <sup>1</sup>												
233-3-03	X				X											
234-3-03	X				X											
236-3-03	X				X											
<b>ALUMINUM ALL-PURPOSE RACKS</b>																
209-3-03	X	X <sup>1</sup>	X <sup>1</sup>	X <sup>1</sup>	X	X	X	X	X							
2097-3-03	X	X <sup>1</sup>	X <sup>1</sup>	X <sup>1</sup>	X	X	X	X	X							
218-3-03										X	X	X	X	X	X	
222-3-03										X	X	X	X	X	X	
<b>STEEL ALL-PURPOSE RACKS</b>																
205-3		X <sup>1</sup>	X <sup>1</sup>	X <sup>1</sup>												
216-3		X <sup>1</sup>	X <sup>1</sup>	X <sup>1</sup>												
2056-3		X <sup>1</sup>	X <sup>1</sup>	X <sup>1</sup>												
20501-3-01	X				X	X	X	X	X							
21501-3-01	X				X	X	X	X	X							
22001-3-01										X	X	X	X			
22002-3-01																X
22101-3-01										X	X	X	X			
22102-3-01																X
22501-3-01	X				X	X	X	X	X							
<b>GLIDESAFE LOAD ASSIST</b>																
23001-3-01	X				X	X	X	X	X							
23003-3-01										X	X	X	X	X		
23004-3-01		X <sup>1</sup>	X <sup>1</sup>	X <sup>1</sup>												

1. Gutter-mounted Van Rack
2. Use 2102-0-01 with 148" WB and 148" XWB Transit 2130-0-01 with 130" WB

# ACCESSORIES



## Steel Work Top

MODEL	DESCRIPTION	HEIGHT	WIDTH	DEPTH	WEIGHT
1 8867-3-01	Steel Work Top	1½"	42"	18"	6 lbs.
2 9912-3-02	2 Drawer Cabinet	12"	16"	13.7"	26 lbs.
3 9914-3-02	2 Drawer Cabinet	12"	16"	13.7"	32 lbs.
4 9444-3-01	Wheel Well Cabinet	13¾"	42¾"	15"	9 lbs.

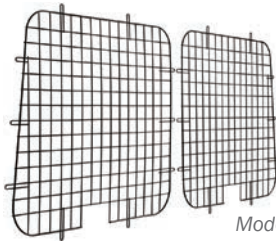

Model 88022

## Window Screens

Welded steel mesh screens add security for vans with windows. Black powder coat finish is durable, reduces glare, and maximizes visibility through screen.

MODEL	VAN TYPE	QTY	DESCRIPTION	WEIGHT
88021	'92 & Newer Ford E-Series	2	Side Door - Hinged	8 lbs.
88022	'92 & Newer Ford E-Series	2	Rear Door -Hinged	8 lbs.
88023	'92 & Newer Ford E-Series	1	Side Door - Sliding	8 lbs.
88026	'96 & Newer Full-Size GM	2	Side Door - Sliding	8 lbs.
88027	'96 & Newer Full-Size GM	2	Side Door - Hinged	7 lbs.
88028	'96 & Newer Full-Size GM	2	Rear Door -Hinged	8 lbs.
88040	'07 & Newer Sprinter	1	Side Door	7 lbs.
88041	'07 & Newer Sprinter	2	Rear Door	9 lbs.
88050	Ram ProMaster®	2	Rear Door	9 lbs.
88051	Ram ProMaster®	1	Side Door	7 lbs.
88052	Ram ProMaster®	1	Side, Fixed	7 lbs.
88054	'14 & Newer Transit Connect		Rear Door	11 lbs.
88055	'14 & Newer Transit Connect 120" WB		Side Door	8 lbs.
88056	'14 & Newer Transit Connect 105" WB		Side Door	8 lbs.
88060	Ford Transit Low-Roof	2	Rear Door	8 lbs.
88061	Ford Transit Low-Roof	1	Side Door - Sliding	8 lbs.
88062	Ford Transit Mid/High-Roof	2	Rear Door	9 lbs.
88063	Ford Transit Mid/High-Roof	1	Side Door	9 lbs.
88064	Ford Transit Low-Roof	2	Side Door - Hinged	8 lbs.

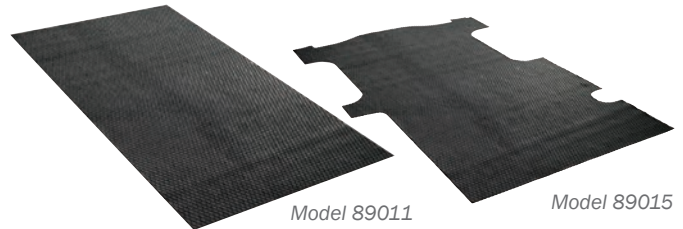

Model 89011

Model 89015

## Van Floor Mats

Designed to cover seating wells in the van floor. Required when installing bulkhead units and other equipment.

MODEL	VAN TYPE	WHEELBASE	WEIGHT
89011	70" x 124" rectangular (must be cut to fit any style vans)		55 lbs.
89015	'96 & Newer GM	135"	55 lbs.
89017	'92 & Newer Ford E-Series	Standard	60 lbs.
89020	'14 & Newer Ram ProMaster®	118"	32 lbs.
89021	'14 & Newer Ram ProMaster®	136"	39 lbs.
89022	'14 & Newer Ram ProMaster®	158"	46 lbs.
89023	'14 & Newer Ram ProMaster®	158" Extended	49 lbs.
89024	'15 & Newer Ford Transit	130"	45 lbs.
89025	'15 & Newer Ford Transit	148"	50 lbs.
89026	'15 & Newer Ford Transit	148" Extended	55 lbs.
89027	'16 & Newer Ram ProMaster City		30 lbs.

MODEL	DESCRIPTION	PAGE
205-3	All-Purpose Steel Van Rack (gutter mount)	31
209-3-03	All Purpose Aluminum Rack (full-size van)	31
210-3	Safari Rack (gutter mount)	32
216-3	3-bar All-Purpose Steel Van Rack (gutter mount)	31
218-3-03	All Purpose Alum Rack (compact van)	31
222-3-03	All Purpose Alum Compact Accessory Cross Member	31
223-3-03	Quick Clamp Rack (compact van, passenger side)	28
224-3-03	Quick Clamp Rack (compact van, dual)	28
225-3-03	Quick Clamp Compact Accessory Cross Member	28
233-3-01	Quick Clamp Accessory Cross Member (gutter mount)	29
233-3-03	Quick Clamp Accessory Cross Member	28
234-3-01	Quick Clamp Rack (full-size, dual, gutter mount)	29
234-3-03	Quick Clamp Rack (full-size, dual)	28
236-3-03	Quick Clamp Rack (full-size, passenger side)	28
237	Conduit Carrier (aluminum 11')	32
238	Conduit Carrier Extension	32
239	Conduit Carrier Kit	32
250	Sliding Ladder Rack	32
301-3	PACK RAT® Drawer Unit	22
303-3	PACK RAT® Drawer Unit	22
304-3	PACK RAT® Drawer Unit	22
305-3	PACK RAT® Drawer Unit	22
306-3	PACK RAT® Drawer Unit	22
307-3	PACK RAT® Drawer Unit	22
308-3	PACK RAT® Drawer Unit	22
308-5	PACK RAT® Drawer Unit	22
310-3-01	PACK RAT® Drawer Unit (12" x 42" x 17")	22
312-3	PACK RAT® Drawer Unit	22
314-3	ITEMIZER® Drawer Unit (Single)	23
316-3	ITEMIZER® Drawer Unit (2 drawer, lateral)	23
317-3	ITEMIZER® Drawer Unit (3 drawer, lateral)	23
318-3	ITEMIZER® Drawer Unit (4 drawer, lateral)	23
326-3	ITEMIZER® Drawer Unit (2 drawer, stacked)	23
327-3	ITEMIZER® Drawer Unit (3 drawer, stacked)	23
328-3	ITEMIZER® Drawer Unit (4 drawer, stacked)	23
334-3	PACK RAT® Drawer Unit	22
335-3	PACK RAT® Drawer Unit	22
336-3	PACK RAT® Drawer Unit	22
337-3	PACK RAT® Drawer Unit	22
338-3	PACK RAT® Drawer Unit	22
338-5	PACK RAT® Drawer Unit	22
902-3-01	2 Drawer Storage Module	18
903-3-01	3 Drawer Storage Module	18
2501	Accessory Warning Light Holder	27





DISTRIBUTED BY:



### LIMITED LIFETIME WARRANTY

Werner Co. (the Manufacturer) warrants to the original purchaser, only, that WEATHER GUARD® van products (the "WEATHER GUARD Product") will be free from defects in material and workmanship from the date of purchase and continuing for the expected lifetime of the WEATHER GUARD Product. Please call our customer service department toll free at 1.800.456.7865 with any questions or comments.

DO NOT use these products for storing or transporting flammables, explosives, hazardous materials or waste, such as gasoline, solvents, gun powder, dynamite, gases or any tanks, torches or gas powered equipment. These products are intended and safe for storing and transporting small tools and other non-combustible, non-flammable materials. Any modification made to, or unintended use of, these products may create a dangerous condition causing death, serious bodily injury or property damage.

#### NOTICE

Any modification or unintended use of these products shall immediately void all manufacturers warranties. Manufacturer disclaims all liability for injuries to persons or property resulting from any modification to, or unintended use of these products.

Ford Transit Connect, Nissan NV, Mercedes Sprinter, and Dodge RAM CV are registered trademarks of their respective owners.

For information on the WEATHER GUARD® Van Solutions Limited Lifetime Warranty, visit [WEATHERGUARD.COM](http://WEATHERGUARD.COM)

To order more WEATHER GUARD® Van Solutions OEM brochures please call us at **800.456.7565**

